

Nikon

DIGITAL CAMERA

COOLPIX S9900



Reference Manual

Introduction	➔ ii
Table of Contents	➔ xvii
Parts of the Camera	➔ 1
Preparing for Shooting	➔ 7
Basic Shooting and Playback Operations	➔ 13
Shooting Features	➔ 22
Functions That Can Be Set with the MENU (Menu) Button	➔ 47
Using Location Data Functions/Displaying Maps	➔ 55
Using the Wi-Fi (Wireless LAN) Function	➔ 56
Connecting the Camera to a TV, Printer, or Computer	➔ 57
Reference Section	➔  1
Technical Notes and Index	➔  1

Introduction

Read This First

To get the most from this Nikon product, be sure to read “For Your Safety” (📖vii-ix), “<Important> Notes About Location Data Functions (GPS/GLONASS, Electronic Compass)” (📖xii), and “Wi-Fi (Wireless LAN Network)” (📖xiv), and all other instructions thoroughly and keep them where they will be read by all who use the camera.

- If you want to start using the camera right away, see “Preparing for Shooting” (📖7) and “Basic Shooting and Playback Operations” (📖13).

Other Information

- Symbols and Conventions

Symbol	Description
	This icon marks cautions and information that should be read before using the camera.
	This icon marks notes and information that should be read before using the camera.
	These icons mark other pages containing relevant information;  : “Reference Section”,  : “Technical Notes and Index.”

- SD, SDHC, and SDXC memory cards are referred to as “memory cards” in this manual.
- The setting at the time of purchase is referred to as the “default setting.”
- The names of menu items displayed in the camera monitor, and the names of buttons or messages displayed on a computer monitor appear in bold.
- In this manual, images are sometimes omitted from monitor display samples so that monitor indicators can be more clearly shown.

How to Attach the Camera Strap

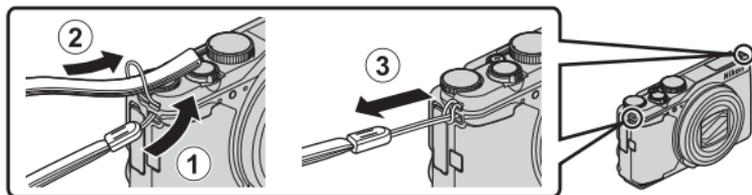

- The camera strap can be attached to the eyelet on either side (left and right) of the camera body.

Information and Precautions

Life-Long Learning

As part of Nikon's "Life-Long Learning" commitment to ongoing product support and education, continually updated information is available online at the following websites:

- For users in the U.S.A.: <http://www.nikonusa.com/>
- For users in Europe and Africa: <http://www.europe-nikon.com/support/>
- For users in Asia, Oceania, and the Middle East: <http://www.nikon-asia.com/>

Visit these websites to keep up-to-date with the latest product information, tips, answers to frequently asked questions (FAQs), and general advice on digital imaging and photography. Additional information may be available from the Nikon representative in your area. Visit the website below for contact information.

<http://imaging.nikon.com/>

Use Only Nikon Brand Electronic Accessories

Nikon COOLPIX cameras are designed to the highest standards and include complex electronic circuitry. Only Nikon brand electronic accessories (including battery chargers, batteries, Charging AC Adapters, AC adapters and, USB cables) certified by Nikon specifically for use with this Nikon digital camera are engineered and proven to operate within the operational and safety requirements of this electronic circuitry. THE USE OF NON-NIKON ELECTRONIC ACCESSORIES COULD DAMAGE THE CAMERA AND MAY VOID YOUR NIKON WARRANTY.

The use of third-party rechargeable Li-ion batteries not bearing the Nikon holographic seal could interfere with normal operation of the camera or result in the batteries overheating, igniting, rupturing, or leaking.

Holographic seal: Identifies this device as an authentic Nikon product.

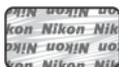

For more information about Nikon brand accessories, contact a local authorized Nikon dealer.

Before Taking Important Pictures

Before taking pictures on important occasions (such as at weddings or before taking the camera on a trip), take a test shot to ensure that the camera is functioning normally. Nikon will not be held liable for damages or lost profits that may result from product malfunction.

About the Manuals

- No part of the manuals included with this product may be reproduced, transmitted, transcribed, stored in a retrieval system, or translated into any language in any form, by any means, without Nikon's prior written permission.
- Illustrations and monitor content shown in this manual may differ from the actual product.
- Nikon reserves the right to change the specifications of the hardware and software described in these manuals at any time and without prior notice.
- Nikon will not be held liable for any damages resulting from the use of this product.
- While every effort was made to ensure that the information in these manuals is accurate and complete, we would appreciate it were you to bring any errors or omissions to the attention of the Nikon representative in your area (address provided separately).

Notice Concerning Prohibition of Copying or Reproduction

Note that simply being in possession of material that was digitally copied or reproduced by means of a scanner, digital camera or other device may be punishable by law.

• Items prohibited by law from being copied or reproduced

Do not copy or reproduce paper money, coins, securities, government bonds or local government bonds, even if such copies or reproductions are stamped "Sample." The copying or reproduction of paper money, coins, or securities which are circulated in a foreign country is prohibited. Unless the prior permission of the government was obtained, the copying or reproduction of unused postage stamps or post cards issued by the government is prohibited.

The copying or reproduction of stamps issued by the government and of certified documents stipulated by law is prohibited.

• Cautions on certain copies and reproductions

The government has issued cautions on copies or reproductions of securities issued by private companies (shares, bills, checks, gift certificates, etc.), commuter passes, or coupon tickets, except when a minimum of necessary copies are to be provided for business use by a company. Also, do not copy or reproduce passports issued by the government, licenses issued by public agencies and private groups, ID cards and tickets, such as passes and meal coupons.

• Comply with copyright notices

The copying or reproduction of copyrighted creative works such as books, music, paintings, woodcut prints, maps, drawings, movies, and photographs is governed by national and international copyright laws. Do not use this product for the purpose of making illegal copies or to infringe copyright laws.

Disposing of Data Storage Devices

Please note that deleting images or formatting data storage devices such as memory cards or built-in camera memory does not completely erase the original image data. Deleted files can sometimes be recovered from discarded storage devices using commercially available software, potentially resulting in the malicious use of personal image data. Ensuring the privacy of such data is the user's responsibility.

Before discarding a data storage device or transferring ownership to another person, erase all data using commercial deletion software, or set **Record location data** of **Location data options** (📖47) to **Off** after formatting the device and then completely refill it with images containing no private information (for example, images of empty sky). Care should be taken to avoid injury or damage to property when physically destroying data storage devices. For the COOLPIX S9900, the log data saved on the memory card is handled in the same way as other data. To erase the log data that is obtained but not stored on the memory card, select **Create log** → **End log** → **Erase log**.

To delete the Wi-Fi settings, select **Restore default settings** in the Wi-Fi options menu (📖47).

Conformity Marking

Follow the procedure below to display some of the conformity markings that the camera complies with.

Press the **MENU** button → **Y** menu icon → **Conformity marking** → **OK** button

For Your Safety

To prevent damage to your Nikon product or injury to yourself or to others, read the following safety precautions in their entirety before using this equipment. Keep these safety instructions where all those who use the product will read them.

The consequences that could result from failure to observe the precautions listed in this section are indicated by the following symbol:



This icon marks warnings, information that should be read before using this Nikon product, to prevent possible injury.

WARNINGS

Turn off in the event of malfunction

Should you notice smoke or an unusual smell coming from the camera or Charging AC Adapter, unplug the Charging AC Adapter and remove the battery immediately, taking care to avoid burns. Continued operation could result in injury. After removing or disconnecting the power source, take the equipment to a Nikon-authorized service representative for inspection.

Do not disassemble

Touching the internal parts of the camera or Charging AC Adapter could result in injury. Repairs should be performed only by qualified technicians. Should the camera or Charging AC Adapter break open as the result of a fall or other accident, take the product to a Nikon-authorized service representative for inspection, after unplugging the product and/or removing the battery.

Do not use the camera or Charging AC Adapter in the presence of flammable gas

Do not use electronic equipment in the presence of flammable gas, as this could result in explosion or fire.

Handle the camera strap with care

Never place the strap around the neck of an infant or child.

Keep out of reach of children

Particular care should be taken to prevent infants from putting the battery or other small parts into their mouths.

Do not remain in contact with the camera, Charging AC Adapter, or AC adapter for extended periods while the devices are on or in use

Parts of the devices become hot. Leaving the devices in direct contact with the skin for extended periods may result in low-temperature burns.

 **Do not leave the product where it will be exposed to extremely high temperatures, such as in an enclosed automobile or in direct sunlight**

Failure to observe this precaution could cause damage or fire.

 **Observe caution when handling the battery**

The battery may leak, overheat, or explode if improperly handled. Observe the following precautions when handling the battery for use in this product:

- Before replacing the battery, turn the product off. If you are using the Charging AC Adapter/AC adapter, be sure it is unplugged.
- Use only a Rechargeable Li-ion Battery EN-EL12 (included). Charge the battery by using a camera that supports battery charging. To perform this operation, use the Charging AC Adapter EH-71P (included) and USB Cable UC-E21 (included). The Battery Charger MH-65 (available separately) is also available to charge the battery without using a camera.
- When inserting the battery, do not attempt to insert it upside down or backwards.
- Do not short or disassemble the battery or attempt to remove or break the battery insulation or casing.
- Do not expose the battery to flame or to excessive heat.
- Do not immerse in or expose to water.
- Put the battery in a plastic bag, etc. in order to insulate it before transporting. Do not transport or store with metal objects such as necklaces or hairpins.
- The battery is prone to leakage when fully discharged. To avoid damage to the product, be sure to remove the battery when no charge remains.
- Discontinue use immediately should you notice any change in the battery, such as discoloration or deformation.
- If liquid from the damaged battery comes in contact with clothing or skin, rinse immediately with plenty of water.

 **Observe the following precautions when handling the Charging AC Adapter**

- Keep dry. Failure to observe this precaution could result in fire or electric shock.
- Dust on or near the metal parts of the plug should be removed with a dry cloth. Continued use could result in fire.
- Do not handle the plug or go near the Charging AC Adapter during lightning storms. Failure to observe this precaution could result in electric shock.
- Do not damage, modify, forcibly tug or bend the USB cable, place it under heavy objects, or expose it to heat or flames. Should the insulation be damaged and the wires become exposed, take it to a Nikon-authorized service representative for inspection. Failure to observe these precautions could result in fire or electric shock.

- Do not handle the plug or Charging AC Adapter with wet hands. Failure to observe this precaution could result in electric shock.
- Do not use with travel converters or adapters designed to convert from one voltage to another or with DC-to-AC inverters. Failure to observe this precaution could damage the product or cause overheating or fire.

 **Use the appropriate power supply (battery, Charging AC Adapter, AC adapter, USB cable)**

Using a power supply other than those provided or sold by Nikon could result in damage or malfunction.

 **Use appropriate cables**

When connecting cables to the input and output jacks, use only the cables provided or sold by Nikon for the purpose, to maintain compliance with product regulations.

 **Do not touch the moving parts of the lens**

Failure to observe this precaution could result in injury.

 **Handle moving parts with care**

Be careful that your fingers or other objects are not pinched by the lens cover or other moving parts.

 **Using the flash close to your subject's eyes could cause temporary visual impairment**

The flash should be no less than 1 meter (3 ft 4 in.) from the subject. Particular care should be observed when photographing infants.

 **Do not operate the flash with the flash window touching a person or object**

Failure to observe this precaution could result in burns or fire.

 **Avoid contact with liquid crystal**

Should the monitor break, care should be taken to avoid injury caused by broken glass and to prevent liquid crystal from the monitor touching the skin or entering the eyes or mouth.

 **Follow the instructions of airline and hospital personnel**

Notices

Notices for Customers in the U.S.A.

IMPORTANT SAFETY INSTRUCTIONS - SAVE THESE INSTRUCTIONS.

DANGER - TO REDUCE THE RISK OF FIRE OR ELECTRIC SHOCK, CAREFULLY FOLLOW THESE INSTRUCTIONS

For connection to a supply not in the U.S.A., use an attachment plug adapter of the proper configuration for the power outlet if needed.

The power supply unit is intended to be correctly orientated in a vertical or floor mount position.

Federal Communications Commission (FCC) Radio Frequency Interference Statement

This equipment has been tested and found to comply with the limits for a Class B digital device, pursuant to Part 15 of the FCC rules. These limits are designed to provide reasonable protection against harmful interference in a residential installation.

This equipment generates, uses, and can radiate radio frequency energy and, if not installed and used in accordance with the instructions, may cause harmful interference to radio communications. However, there is no guarantee that interference will not occur in a particular installation. If this equipment does cause harmful interference to radio or television reception, which can be determined by turning the equipment off and on, the user is encouraged to try to correct the interference by one or more of the following measures:

- Reorient or relocate the receiving antenna.
- Increase the separation between the equipment and receiver.
- Connect the equipment into an outlet on a circuit different from that to which the receiver is connected.
- Consult the dealer or an experienced radio/television technician for help.

CAUTIONS

Modifications

The FCC requires the user to be notified that any changes or modifications made to this device that are not expressly approved by Nikon Corporation may void the user's authority to operate the equipment.

Interface Cables

Use the interface cables sold or provided by Nikon for your equipment. Using other interface cables may exceed the limits of Class B Part 15 of the FCC rules.



Notice for Customers in the State of California

WARNING

Handling the cord on this product will expose you to lead, a chemical known to the State of California to cause birth defects or other reproductive harm.

Wash hands after handling.

Nikon Inc.,

1300 Walt Whitman Road, Melville, New York 11747-3064, U.S.A.

Tel: 631-547-4200

Notice for Customers in Canada

CAN ICES-3 B / NMB-3 B

Notices for Customers in Europe

CAUTIONS

RISK OF EXPLOSION IF BATTERY IS REPLACED BY AN INCORRECT TYPE.

DISPOSE OF USED BATTERIES ACCORDING TO THE INSTRUCTIONS.

This symbol indicates that electrical and electronic equipment is to be collected separately.

The following apply only to users in European countries:

- This product is designated for separate collection at an appropriate collection point. Do not dispose of as household waste.
- Separate collection and recycling helps conserve natural resources and prevent negative consequences for human health and the environment that might result from incorrect disposal.
- For more information, contact the retailer or the local authorities in charge of waste management.



This symbol on the battery indicates that the battery is to be collected separately.

The following apply only to users in European countries:

- All batteries, whether marked with this symbol or not, are designated for separate collection at an appropriate collection point. Do not dispose of as household waste.
- For more information, contact the retailer or the local authorities in charge of waste management.



<Important> Notes About Location Data Functions (GPS/GLONASS, Electronic Compass)

● Map/location name data of this camera

Before using the location data functions, make sure to read "USER LICENSE AGREEMENT FOR MAP DATA AND LOCATION NAME DATA" (P.21) and agree to the terms.

- The maps and location name information (Points of Interest: POI) are as of April 2014.
The maps and location name information will not be updated.
- The details of geological formations are displayed simplistically according to the scale of a map. The scale of a map and level of detail of the location data vary depending on country and region.
If the latitude becomes higher, the horizontal and vertical scales displayed on the monitor vary, therefore displayed geological formations differ from the actual formations. Use the maps and location name information only as a guide.
- The detailed map data and location name information (Points of Interest: POI) of the People's Republic of China ("China") and the Republic of Korea are not provided for the COOLPIX S9900.

● Notes about record location data functions and log recording

- When **Record location data** in **Location data options** of the Location data options menu is set to **On** or during log recording, record location data functions and log recording function will continue to operate even after the camera is turned off (P.33).
- An individual may be identified from still images or movies that have been recorded with location data. Observe caution when you transfer still images or movies recorded with location data, or log files to a third party or upload them to a network such as the Internet where the public can view them. Make sure to read "Disposing of Data Storage Devices" (P.vi).

● Notes about measurement functions

The COOLPIX S9900 is a camera. Do not use this camera as a navigation device or measuring instrument.

- Use information (such as direction) measured by the camera as a guideline only. Do not use this information for navigation of an airplane, car, and person or land survey applications.
- When you use the camera for mountain climbing or trekking, make sure to take a map, navigation device, or measuring instrument separately.

● Using the camera overseas

- Before taking the camera with location data functions overseas for travel, consult your travel agency or embassy of the country you are visiting to confirm whether there is any restriction on use. For example, you cannot record location data logs without permission from the government in China. Set **Record location data** to **Off**.
- The location data may not function properly in China and on the borders between China and neighboring countries (as of December 2014).

Wi-Fi (Wireless LAN Network)

This product is controlled by the United States Export Administration Regulations, and you are required to obtain permission from the United States government if you export or re-export this product to any country to which the United States embargoes goods. The following countries were subject to embargo: Cuba, Iran, North Korea, Sudan, and Syria. Since the target countries are subject to change, please contact the United States Department of Commerce for the latest information.

Restrictions on Wireless Devices

The wireless transceiver included in this product conforms to wireless regulations in the country of sale and is not for use in other countries (products purchased in the EU or EFTA can be used anywhere within the EU and EFTA). Nikon does not accept liability for use in other countries. Users who are unsure as to the original country of sale should consult with their local Nikon service center or Nikon-authorized service representative. This restriction applies to wireless operation only and not to any other use of the product.

Notice for Customers in the U.S.A. and Canada

Federal Communications Commission (FCC) and Industry of Canada (IC)

Declaration of Conformity

This device complies with Part 15 of FCC Rules and Industry Canada licence-exempt RSS standard(s). Operation is subject to the following two conditions: (1) this device may not cause interference, and (2) this device must accept any interference, including interference that may cause undesired operation of this device.

FCC/IC RF Exposure Statement

This transmitter must not be co-located or operated in conjunction with any other antenna or transmitter.

The available scientific evidence does not show that any health problems are associated with using low power wireless devices. There is no proof, however, that these low power wireless devices are absolutely safe. Low power wireless devices emit low levels of radio frequency energy (RF) in the microwave range while being used. Whereas high levels of RF can produce health effects (by heating tissue), exposure of low-level RF that does not produce heating effects causes no known adverse health effects. Many studies of low-level RF exposures have not found any biological effects. Some studies have suggested that some biological effects might occur, but such findings have not been confirmed by additional research.

COOLPIX S9900, which is equipped with a DW092 (FCC ID:EW4DW092 / IC ID:4634A-3149EC) Wireless LAN Module, has been tested and found to comply with FCC/IC radiation exposure limits set forth for an uncontrolled environment and meets the FCC radio frequency (RF) Exposure Guidelines in Supplement C to OET65 and RSS-102 of the IC radio frequency (RF) Exposure rules. Please refer to the SAR test report that was uploaded to FCC website.

Declaration of Conformity (Europe)

Hereby, Nikon Corporation, declares that COOLPIX S9900 is in compliance with the essential requirements and other relevant provisions of Directive 1999/5/EC. The declaration of conformity may be consulted at http://imaging.nikon.com/support/pdf/DoC_S9900.pdf.

Notice for Customers in Jamaica

This product contains a Type Approved Module by Jamaica:
"SMA - DW092"

Precautions when Using Radio Transmissions

Always keep in mind that radio transmission or reception of data is subject to interception by third parties. Note that Nikon is not responsible for data or information leaks that may occur during data transfer.

Personal Information Management and Disclaimer

- User information registered and configured on the product, including wireless LAN connection settings and other personal information, is susceptible to alteration and loss resulting from operational error, static electricity, accident, malfunction, repair or other handling. Always keep separate copies of important information. Nikon is not responsible for any direct or indirect damages or lost profits resulting from alteration or loss of content that is not attributable to Nikon.
- Before discarding this product or transferring it to another owner, perform **Reset all** in the setup menu (📖54) to delete all user information registered and configured with the product, including wireless LAN connection settings and other personal information.

Table of Contents

Introduction	ii
Read This First	ii
Other Information.....	ii
How to Attach the Camera Strap.....	iii
Information and Precautions.....	iv
For Your Safety	vii
WARNINGS	vii
Notices	x
<Important> Notes About Location Data Functions (GPS/GLONASS, Electronic Compass).....	xii
Wi-Fi (Wireless LAN Network).....	xiv
<hr/>	
Parts of the Camera	1
The Camera Body.....	1
The Monitor	3
Shooting Mode	3
Playback Mode	5
<hr/>	
Preparing for Shooting.....	7
Insert the Battery and Memory Card	7
Removing the Battery or Memory Card.....	7
Memory Cards and Internal Memory.....	7
Charge the Battery	8
Opening and Adjusting the Angle of the Monitor	10
Turn the Camera On and Set the Display Language, Date, and Time	11
<hr/>	
Basic Shooting and Playback Operations.....	13
Shooting with  (Auto) Mode.....	13
Using the Flash	16
Using the Zoom.....	17
The Shutter-release Button.....	17
Play Back Images.....	18
Delete Images	19
Changing the Shooting Mode	20
Recording Movies	20
Functions That Can Be Set with the Multi Selector (When Shooting)	21

Shooting Features	22
 (Auto) Mode	22
Scene Mode (Shooting Suited to Scenes)	23
Smart Portrait Mode (Enhancing Human Faces When Shooting)	25
Using Smile Timer	26
Using Self-Collage	27
Short Movie Show Mode (Combining Movie Clips to Create Short Movies)	28
P, S, A, M Modes (Setting the Exposure for Shooting)	31
Flash Mode	35
Self-timer	37
Macro Mode (Taking Close-up Pictures)	39
Creative Slider (Adjusting Brightness (Exposure Compensation), Vividness, and Hue)	40
Exposure Compensation (Adjusting Brightness)	43
Functions That Cannot Be Used Simultaneously When Shooting	44
<hr/>	
Functions That Can Be Set with the MENU (Menu) Button	47
The Shooting Menu	49
Common Options	49
For P, S, A, M modes	49
For Smart Portrait mode	50
The Movie Menu	51
The Playback Menu	52
The Image Selection Screen	53
The Setup Menu	54
<hr/>	
Using Location Data Functions/Displaying Maps	55
<hr/>	
Using the Wi-Fi (Wireless LAN) Function	56
Installing the Software on the Smart Device	56
<hr/>	
Connecting the Camera to a TV, Printer, or Computer	57

Reference Section 01

Tips and Notes on the Scene Mode	03
Shooting Time-lapse Movies	09
Shooting with Easy Panorama	11
Playback with Easy Panorama	13
Default Settings (Flash, Self-timer, Etc.)	14
Focusing	16
Using Face Detection	16
Using Skin Softening	17
Subjects Not Suitable for Autofocus	17
Using Target Finding AF	18
Focus Lock	19
The Control Range of the Shutter Speed (P, S, A, or M Modes)	20
Playback Zoom	21
Thumbnail Playback/Calendar Display	22
List by Date Mode	23
Viewing and Deleting Images Captured Continuously (Sequence)	24
Viewing Images in a Sequence	24
Deleting Images in a Sequence	25
Editing Images (Still Images)	26
Before Editing Images	26
Quick Effects: Changing Hue or Mood	26
Quick Retouch: Enhancing Contrast and Saturation	27
D-Lighting: Enhancing Brightness and Contrast	27
Red-eye Correction: Correcting Red-eye When Shooting with the Flash ...	28
Glamour Retouch: Enhancing Human Faces	28
Small Picture: Reducing the Size of an Image	30
Crop: Creating a Cropped Copy	31
Recording the Location Data on the Image	32
Displaying the Shooting Location on the Map (While in Playback Mode)	35
Displaying the Current Position on the Map (While in Shooting Mode) ...	38
Recording the Log of Movement Information	39
Ending Log Recording to Save it on Memory Cards	41
Viewing the Log of Location Data on the Map	42
Recording and Playing Back Movies	43
Capturing Still Images While Recording Movies	46
Operations During Movie Playback	47

Editing Movies	48
Extracting Only the Desired Portion of a Movie.....	48
Saving a Frame from a Movie as a Still Image	49
Connecting to a Smart Device (Wi-Fi)	50
Preselecting Images in the Camera That You Want to Transfer to a Smart Device	52
Connecting the Camera to a TV (Playback on a TV)	53
Connecting the Camera to a Printer (Direct Print)	54
Connecting the Camera to a Printer.....	54
Printing Images One at a Time	55
Printing Multiple Images.....	56
Using ViewNX 2 (Transferring Images to a Computer)	58
Installing ViewNX 2	58
Transferring Images to a Computer.....	58
The Shooting Menu (The Common Shooting Options)	60
Image Quality	60
Image Size.....	61
The Shooting Menu (P, S, A, or M Mode)	62
White Balance (Adjusting Hue)	62
Metering	64
Continuous Shooting	65
ISO Sensitivity	68
AF Area Mode.....	69
Autofocus Mode.....	72
M Exposure Preview	72
The Smart Portrait Menu	73
Self-Collage	73
Blink Proof.....	74
The Movie Menu	75
Movie Options.....	75
AF Area Mode.....	79
Autofocus Mode.....	80
Movie VR.....	81
Wind Noise Reduction	81
Frame Rate	82
The Playback Menu	82
Mark for Wi-Fi Upload	82
Slide Show	83
Protect.....	84
Rotate Image	84

Copy (Copy Between the Memory Card and Internal Memory).....	85
Sequence Display Options.....	86
The Location Data Options Menu.....	87
Location Data Options	87
Distance Units	88
Calculate Distance.....	89
Points of Interest (POI) (Recording and Displaying Location Name Information).....	90
Set Clock from Satellite.....	91
Electronic Compass	91
The Wi-Fi Options Menu.....	93
Operating the Text Input Keyboard	94
The Setup Menu	95
Time Zone and Date	95
Monitor Settings.....	97
Date Stamp	99
Photo VR	100
AF Assist.....	101
Digital Zoom	101
Sound Settings	102
Auto Off	102
Format Card/Format Memory.....	103
Language	103
Charge by Computer.....	104
Reset All.....	105
Conformity Marking	105
Firmware Version	105
Error Messages.....	106
File Names	111
Optional Accessories	112

Technical Notes and Index.....  1

Caring for the Product	 2
The Camera.....	 2
The Battery	 3
The Charging AC Adapter.....	 4
Memory Cards.....	 5
Cleaning and Storage	 6
Cleaning.....	 6
Storage	 6
Troubleshooting	 7
Specifications	 15
Approved Memory Cards.....	 19
USER LICENSE AGREEMENT FOR MAP DATA AND LOCATION NAME	
DATA	 21
Index	 27

Parts of the Camera

The Camera Body

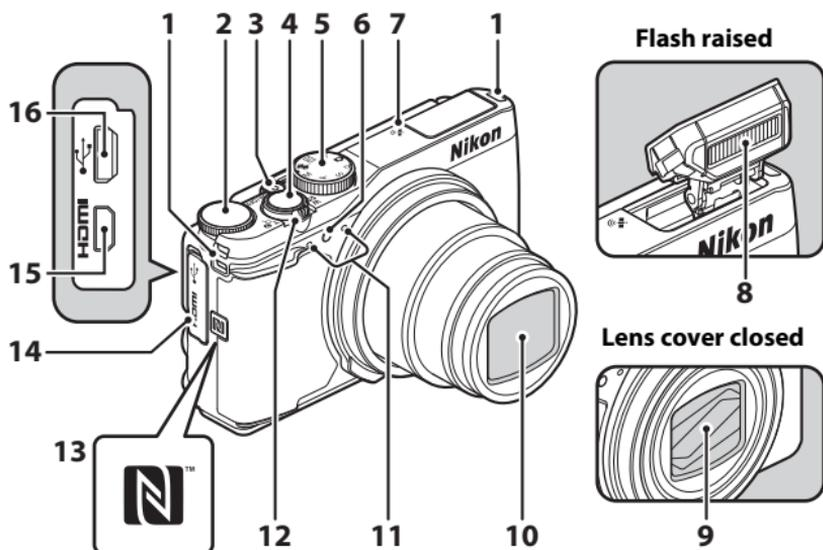

1	Eyelet for camera strap.....	iii
2	Command dial.....	31
3	Power switch/power-on lamp	11
4	Shutter-release button.....	14
5	Mode dial.....	13, 20
6	Self-timer lamp.....	38
	AF-assist illuminator.....	54
7	Positioning antenna	33
8	Flash.....	35
9	Lens cover	
10	Lens	
11	Microphone (stereo).....	13

12	Zoom control.....	17
	W : wide-angle.....	17
	T : telephoto.....	17
	: thumbnail playback	18, 22
	: playback zoom	18, 21
	: help	24
13	N-Mark (NFC antenna)	51, 52
14	Connector cover.....	8, 57, 58
15	HDMI micro connector (Type D)	57
16	Micro-USB connector	8, 57, 58

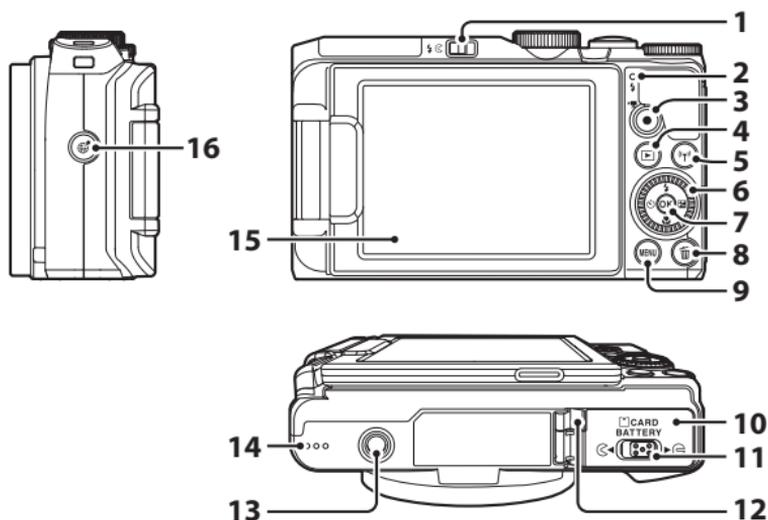

1	(flash pop-up) control 16, 35	9	MENU (menu) button..... 47
2	Charge lamp..... 8 Flash lamp..... 16	10	Battery-chamber/ memory card slot cover 7
3	(movie-record) button 20, 43	11	Lock lever 7
4	(playback) button..... 18	12	Power connector cover (for optional AC adapter)
5	(Wi-Fi) button..... 56, 50	13	Tripod socket
6	Rotary multi selector (multi selector)* 18, 21, 48	14	Speaker
7	(apply selection) button 48	15	Monitor 3
8	(delete) button..... 19	16	(map) button 55

* Also referred to as the “multi selector” in this manual.

The Monitor

The information that is displayed in the monitor during shooting and playback changes depending on the camera's settings and state of use.

By default, information is displayed when the camera is first turned on and when you operate the camera, and turns off after a few seconds (when **Photo info** is set to **Auto info** in **Monitor settings** (📖54)).

Shooting Mode

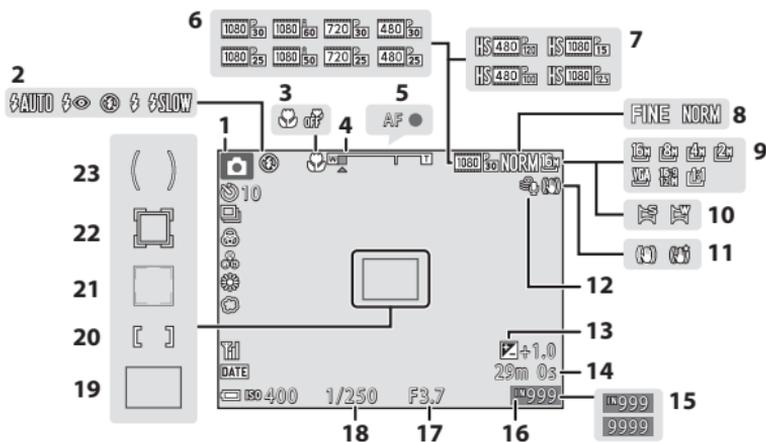

1	Shooting mode.....	20
2	Flash mode.....	35
3	Macro mode.....	39
4	Zoom indicator.....	17, 39
5	Focus indicator.....	14
6	Movie options (normal speed movies).....	51, 📷75
7	Movie options (HS movies).....	51, 📷76
8	Image quality.....	49, 📷60
9	Image size.....	49, 📷61
10	Easy panorama.....	📷111
11	Vibration reduction icon.....	51, 54
12	Wind noise reduction.....	51
13	Exposure compensation value.....	41, 43

14	Remaining movie recording time.....	📷43
15	Number of exposures remaining (still images).....	13
16	Internal memory indicator.....	13
17	Aperture value.....	17, 31
18	Shutter speed.....	17, 31
19	Focus area (target finding AF).....	50, 📷18
20	Focus area (manual or center).....	50, 📷19
21	Focus area (face detection, pet detection).....	50, 📷7, 📷16
22	Focus area (subject tracking).....	50, 📷71
23	Center-weighted area.....	49

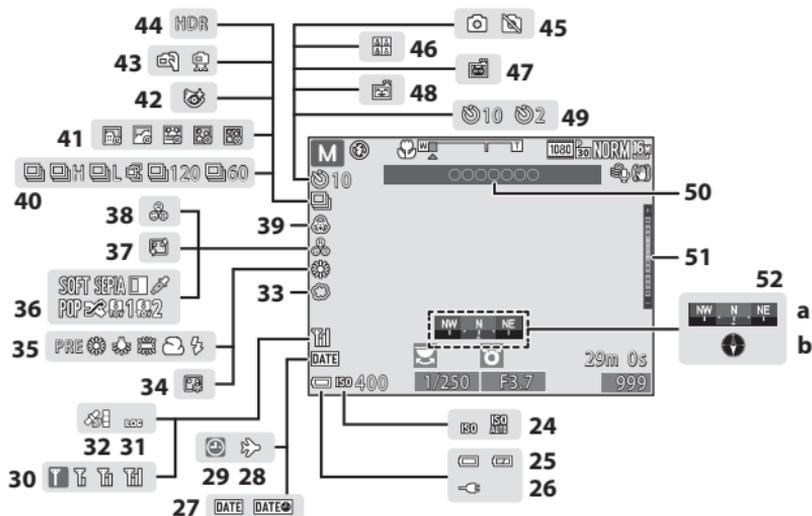

24	ISO sensitivity.....	49	40	Continuous shooting mode.....	49
25	Battery level indicator.....	13	41	Time-lapse movie.....	23
26	Charging AC adapter connection indicator.....		42	Blink proof icon.....	50
27	Date stamp.....	54	43	Hand-held/tripod.....	4, 5
28	Travel destination icon.....	95	44	Backlighting (HDR).....	6
29	"Date not set" indicator.....	8	45	Still image capture (during movie recording).....	46
30	Wi-Fi communication indicator.....	56	46	Self-Collage.....	27
31	Log display.....	39	47	Pet portrait auto release.....	7
32	Location data reception.....	34	48	Smile timer.....	26
33	Soft.....	25	49	Self-timer indicator.....	37
34	Foundation makeup.....	25		Location name information (POI information).....	34
35	White balance mode.....	49	50	Exposure indicator.....	33
36	Special effects.....	28		Compass display.....	91
37	Skin softening.....	25, 29	52	(a) Direction gauge	
38	Hue.....	42		(b) Compass	
39	Vividness.....	42			

Playback Mode

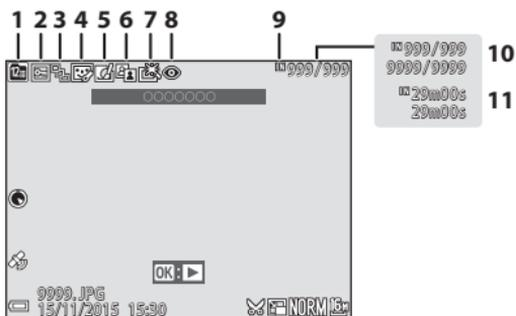

- 1** List by date icon 23
- 2** Protect icon 52, 84
- 3** Sequence display (when **Individual pictures** is selected) 53, 86
- 4** Glamour retouch icon 52, 28
- 5** Quick effects icon 18, 26

- 6** D-Lighting icon 52, 27
- 7** Quick retouch icon 52, 27
- 8** Red-eye correction 52, 28
- 9** Internal memory indicator 13
- 10** Current image number/ total number of images
- 11** Movie length or elapsed playback time

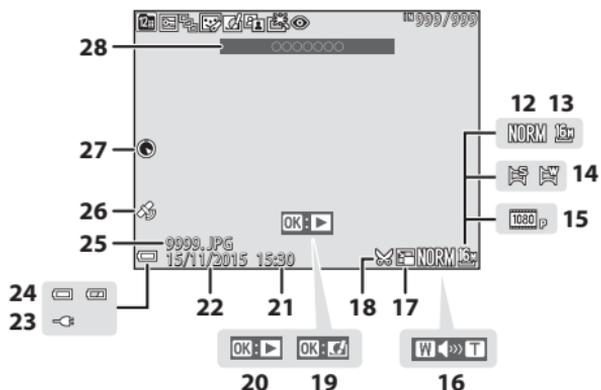

- | | | | | | | |
|--|-----|-----|---|---|-----|----|
| 12 Image quality | 49, | 60 | 21 Time of recording | | | |
| 13 Image size | 49, | 61 | 22 Date of recording | | | |
| 14 Easy panorama | | 11 | 23 Charging AC adapter connection indicator | | | |
| 15 Movie options | 51, | 75 | 24 Battery level indicator | 13 | | |
| 16 Volume indicator | | 47 | 25 File number and type | | 111 | |
| 17 Small picture icon | 52, | 30 | 26 Recorded location data indicator | | 34 | |
| 18 Crop icon | | 21, | 31 | 27 Compass display (compass) | | 91 |
| 19 Quick effects guide | | | 28 Location name information (POI information) | | 34 | |
| 20 Easy panorama playback guide | | | | | | |
| Sequence playback guide | | | | | | |
| Movie playback guide | | | | | | |

Preparing for Shooting

Insert the Battery and Memory Card

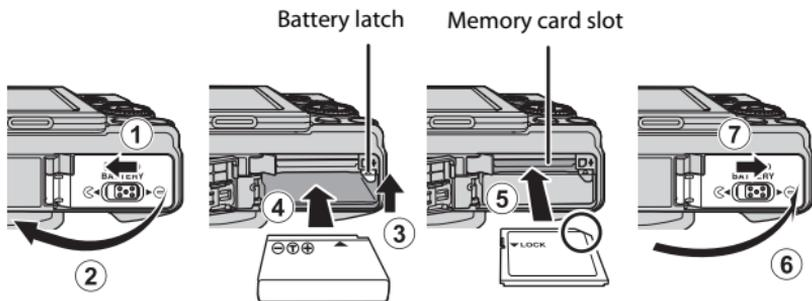

- With the battery's positive and negative terminals oriented correctly, move the orange battery latch (3), and fully insert the battery (4).
- Slide the memory card in until it clicks into place (5).
- Be careful not to insert the battery or memory card upside-down or backward, as this could cause a malfunction.

Formatting a Memory Card

The first time you insert a memory card that has been used in another device into this camera, make sure to format it with this camera. Insert the card into the camera, press the **MENU** button, and select **Format card** in the setup menu (54).

Removing the Battery or Memory Card

Turn the camera off and make sure that the power-on lamp and monitor have turned off, and then open the battery-chamber/memory card slot cover.

- Move the battery latch to eject the battery.
- Gently push the memory card into the camera to partially eject the memory card.
- Be careful when handling the camera, battery, and memory card immediately after using the camera, as they may become hot.

Memory Cards and Internal Memory

Camera data, including images and movies, can be saved either on a memory card or in the camera's internal memory. To use the camera's internal memory, remove the memory card.

Notes About the USB Cable

- Do not use a USB cable other than the UC-E21. Using a USB cable other than the UC-E21 could result in overheating, fire or electric shock.
- Make sure that the plugs are properly oriented. Do not insert or remove the plugs at an angle when connecting or disconnecting them.

Notes About Charging the Battery

Do not, under any circumstances, use another make or model of AC adapter other than Charging AC Adapter EH-71P, and do not use a commercially available USB-AC adapter or a battery charger for a mobile phone. Failure to observe this precaution could result in overheating or in damage to the camera.

Charging Using a Computer or Battery Charger

- You can also charge the battery by connecting the camera to a computer.
- You can use the Battery Charger MH-65 (available separately) to charge the battery without using the camera.

Opening and Adjusting the Angle of the Monitor

Changing the orientation of the monitor is useful when shooting with the camera in a high or a low position, or when taking selfies.

For normal shooting, fold the monitor against the camera body with the screen facing out (③).

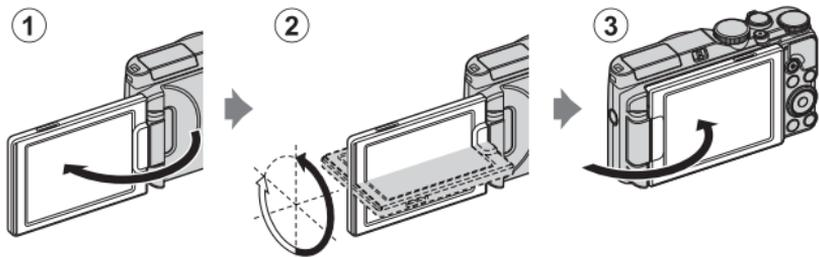

When you are not using or carrying the camera, fold the monitor against the camera body with the screen facing inward to prevent scratches or contamination.



Notes About the Monitor

When moving the monitor, do not apply excessive force and turn slowly within the monitor's adjustable range so that the connection will not be damaged.

Turn the Camera On and Set the Display Language, Date, and Time

When the camera is turned on for the first time, the language-selection screen and the date and time setting screen for the camera clock are displayed.

1 Press the power switch to turn on the camera.

- The monitor turns on.
- To turn the camera off, press the power switch again.
- The power switch is enabled a few seconds after the battery is inserted. Wait a few seconds before pressing the power switch.

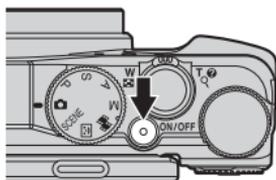

2 Use the multi selector ▲▼ to select the desired language and press the **OK** button.

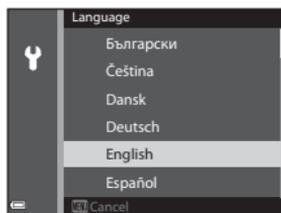

3 Select **Yes** and press the **OK** button.

4 Select your home time zone and press the **OK** button.

- Press ▲ to display  above the map and enable daylight saving time. Press ▼ to disable it.



5 Use ▲▼ to select the date format and press the **OK** button.

6 Set the date and time, and press the **OK** button.

- Use ◀▶ to select a field and then use ▲▼ to set the date and time.
- Select the minute field and press the **OK** button to confirm the setting.

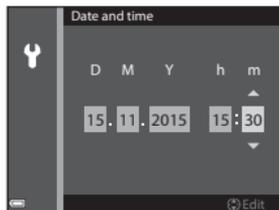

7 When the confirmation dialog is displayed, use ▲▼ to select **Yes** and press the **OK** button.

- When settings are finished, the lens extends and the camera switches to shooting mode.

Changing the Language or the Date and Time Setting

- You can change these settings using the **Language** and **Time zone and date** settings in the **Y** setup menu (📖54).
- You can enable or disable daylight saving time in the **Y** setup menu by selecting **Time zone and date** followed by **Time zone**. Enabling daylight saving time moves the clock forward one hour, and disabling it moves the clock back one hour.

The Clock Battery

- The camera's clock is powered by a built-in backup battery. The backup battery charges when the main battery is inserted into the camera or when the camera is connected to an optional AC adapter, and it can run the clock for several days after about 10 hours of charging.
- If the camera's backup battery becomes exhausted, the date and time setting screen is displayed when the camera is turned on. Set the date and time again (📖11).

Basic Shooting and Playback Operations

Shooting with (Auto) Mode

1 Rotate the mode dial to .

- The camera enters  (auto) mode and can be used for general shooting.
- Battery level indicator
: The battery level is high.
: The battery level is low.
- Number of exposures remaining
 is displayed when no memory card is inserted in the camera, and images are saved in the internal memory.

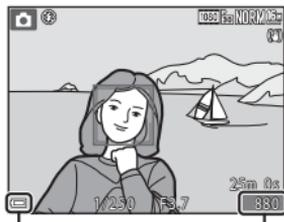
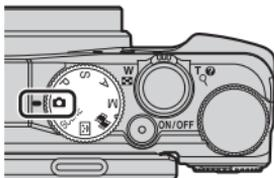

Battery level indicator

Number of exposures remaining

2 Hold the camera steady.

- Keep fingers and other objects away from the lens, flash, AF-assist illuminator, microphones, and speaker.
- When taking pictures in portrait ("tall") orientation, turn the camera so that the flash is above the lens.

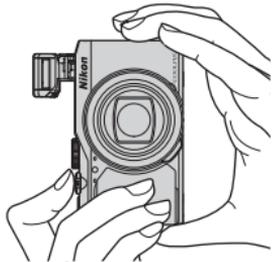

3 Frame the picture.

- Move the zoom control to change the zoom lens position (📖 17).

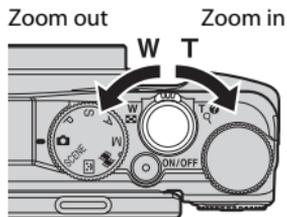

4 Press the shutter-release button halfway.

- When the subject is in focus, the focus area or focus indicator is displayed in green.
- When you are using digital zoom, the camera focuses in the center of the frame and the focus area is not displayed.
- If the focus area or focus indicator flashes, the camera is unable to focus. Modify the composition and try pressing the shutter-release button halfway again.

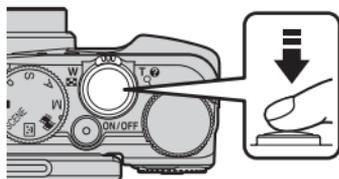

5 Without lifting your finger, press the shutter-release button the rest of the way down.



Notes About Saving Images or Movies

The indicator showing the number of exposures remaining or the indicator showing remaining recording time flashes while images or movies are being saved. **Do not open the battery-chamber/memory card slot cover or remove the battery or memory card** while an indicator is flashing. Doing this could result in loss of data, or in damage to the camera or the memory card.

The Auto Off Function

- When no operations are performed for about one minute, the monitor turns off, the camera enters standby mode, and then the power-on lamp flashes. The camera turns off after remaining in standby mode for about three minutes.
- To turn the monitor back on while the camera is in standby mode, perform an operation such as pressing the power switch or shutter-release button.

When Using a Tripod

- We recommend using a tripod to stabilize the camera in the following situations:
 - When shooting in dim lighting with the flash mode set to  (off)
 - When the zoom is at a telephoto position
- When using a tripod to stabilize the camera during shooting, set **Photo VR** to **Off** in the setup menu (54) to prevent potential errors caused by this function.

Using the Flash

In situations where a flash is needed, such as in dark locations or when the subject is backlit, move the  (flash pop-up) control to raise the flash.

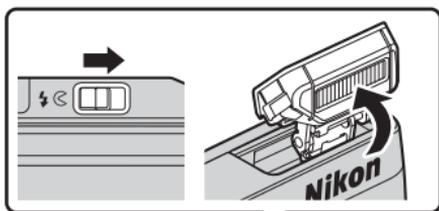

- When not using the flash, gently push to lower the flash until it clicks shut.



The Flash Lamp

- The status of the flash can be confirmed by pressing the shutter-release button halfway.
 - On: The flash fires when you press the shutter-release button all the way down.
 - Flashing: The flash is charging. The camera cannot shoot images.
 - Off: The flash does not fire when a picture is taken.
- If the battery level is low, the monitor turns off while the flash is charging.

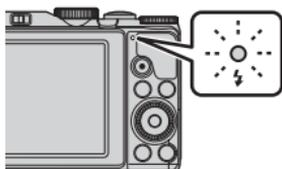

Using the Zoom

When you move the zoom control, the zoom lens position changes.

- To zoom in: Move toward **T**
- To zoom out and view a larger area: Move toward **W**

When you turn the camera on, the zoom moves to the maximum wide-angle position.

- A zoom indicator is displayed on the shooting screen when the zoom control is moved.
- Digital zoom, which allows you to further magnify the subject up to approximately 4x the maximum optical zoom ratio, can be activated by moving and holding the zoom control toward **T** when the camera is zoomed in to the maximum optical zoom position.

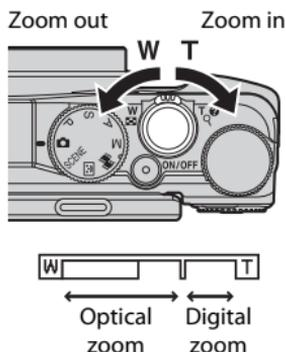

Digital Zoom

The zoom indicator changes to blue when the digital zoom is activated, and it changes to yellow when the zoom magnification is increased further.

- Zoom indicator is blue: Image quality is not noticeably reduced by using the Dynamic Fine Zoom.
- Zoom indicator is yellow: There may be cases in which image quality is noticeably reduced.
- The indicator remains blue across a wider area when the image size is smaller.

The Shutter-release Button

<p>Press halfway</p> 	<p>To set focus and exposure (shutter speed and aperture value), press the shutter-release button lightly until you feel a slight resistance. Focus and exposure remain locked while the shutter-release button is pressed halfway.</p>
<p>Press all the way</p> 	<p>Press the shutter-release button all the way to release the shutter and take a picture. Do not use force when pressing the shutter-release button, as this may result in camera shake and blurred images. Press the button gently.</p>

Play Back Images

1 Press the  (playback) button to enter playback mode.

- If you press and hold down the  (playback) button while the camera is turned off, the camera turns on in playback mode.

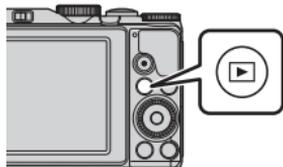

2 Use the multi selector to select an image to display.

- Press and hold down  to scroll through the images quickly.
- Images can also be selected by rotating the multi selector.
- To play back a recorded movie, press the  button.
- To return to shooting mode, press the  button or shutter-release button.
- When :  is displayed in full-frame playback mode, you can press the  button to apply an effect to the image.

Display the previous image



Display the next image

- Move the zoom control toward  in full-frame playback mode to zoom in on an image.



- In full-frame playback mode, move the zoom control toward  to switch to thumbnail playback mode and display multiple images on the screen.



Delete Images

- 1 Press the  (delete) button to delete the image currently displayed in the monitor.

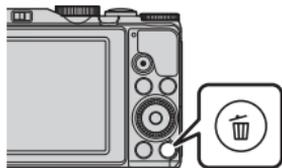

- 2 Use the multi selector   to select the desired deletion method and press the  button.

- To exit without deleting, press the **MENU** button.
- When **Erase selected images** is selected, see "The Image Selection Screen" (p. 53).

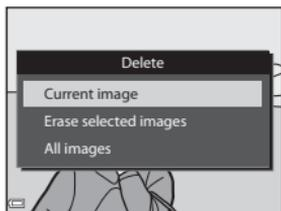

- 3 Select **Yes** and press the  button.

- Deleted images cannot be recovered.

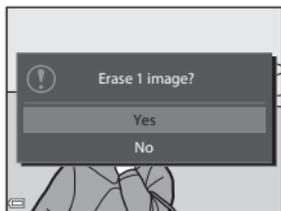

Deleting Images Captured Continuously (Sequence)

- Images captured continuously are saved as a sequence, and only the first image of the sequence (the key picture) is displayed in playback mode.
- If you press the  button while a key picture is displayed for a sequence of images, all images in the sequence are deleted.
- To delete individual images in a sequence, press the  button to display them one at a time and press the  button.



Deleting the Image Captured While in Shooting Mode

When using shooting mode, press the  button to delete the last image that was saved.

Changing the Shooting Mode

Rotate the mode dial to select one of the following shooting modes.

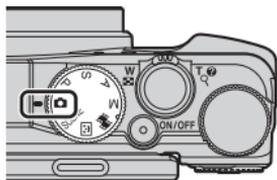

- **📷 (Auto) mode**

Used for general shooting.

- **SCENE (Scene) mode**

Camera settings are optimized according to the scene that you select.

When using scene auto selector, the camera automatically recognizes the shooting scene when you frame a picture, making it easier to take pictures using settings that suit the scene.

In time-lapse movie scene mode, the camera can automatically capture 300 still images at a specified interval to create time-lapse movies (1080p 1080/30p) that are approximately 10 seconds long.

When using special effects, effects can be applied to images during shooting.

- **😊 (Smart portrait) mode**

Use glamour retouch to enhance human faces during shooting, and use the smile timer or self-collage function to take pictures.

- **🎞️ (Short movie show) mode**

You can create a short movie (1080p 1080/30p or 1080p 1080/25p) that is up to 30 seconds long by recording and automatically combining multiple movie clips that are several seconds long.

- **P, S, A, M modes**

Select these modes for greater control over shutter speed and aperture value.

Recording Movies

Display the shooting screen and press the **●** (▶️) (movie-record) button to start recording a movie. Press the **●** (▶️) button again to end recording.

- To play back a movie, select a movie in full-frame playback mode and press the **OK** button.

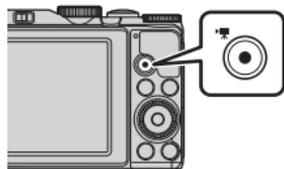

Functions That Can Be Set with the Multi Selector (When Shooting)

When the shooting screen is displayed, you can press the multi selector ▲(⚡) ◀(⌚) ▼(🌸) ▶(📷) to set the functions described below.



- **⚡ Flash mode**
When the flash is raised, you can select a flash mode to match the shooting conditions.
- **⌚ Self-timer**
The camera releases the shutter 10 seconds or 2 seconds after you press the shutter-release button.
- **🌸 Macro mode**
Use macro mode when you take close-up pictures.
- **📷 Creative slider (📷 brightness (exposure compensation), 🌸 vividness, and 🎛 hue)**
In 📷 (auto) mode, scene mode, or short movie show mode, you can adjust overall image brightness (exposure compensation).
In **P, S, A, M** mode, you can adjust overall image brightness, vividness, and hue.
In smart portrait mode, you can apply glamour retouch to enhance human faces.

The functions that can be set vary depending on the shooting mode.

Shooting Features

(Auto) Mode

Used for general shooting.

- When the camera detects a human face, it focuses on that face (face detection).

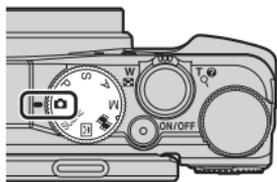

Functions Available in (Auto) Mode

- Flash mode ( 35)
- Self-timer ( 37)
- Macro mode ( 39)
- Exposure compensation ( 43)
- Shooting menu ( 49)

Scene Mode (Shooting Suited to Scenes)

When a scene is selected, camera settings are automatically optimized for the selected scene.

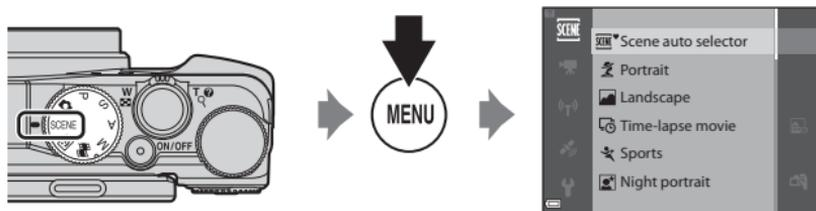

Press the **MENU** (menu) button to display the scene menu and select a scene using the multi selector.

Scene auto selector (default setting) (📷3)	Dusk/dawn ^{1, 2, 3}
Portrait	Night landscape (📷5) ^{1, 2}
Landscape ^{1, 2}	Close-up (📷5)
Time-lapse movie (📷9) ²	Food (📷5)
Sports (📷4) ²	Fireworks show (📷6) ^{1, 3}
Night portrait (📷4)	Backlighting (📷6) ²
Party/indoor (📷4) ²	Easy panorama (📷11)
Beach ²	Pet portrait (📷7)
Snow ²	Special effects (📷8) ²
Sunset ^{2, 3}	

¹ The camera focuses at infinity.

² The camera focuses on the area in the center of the frame.

³ Use of a tripod is recommended because the shutter speed is slow. Set **Photo VR** to **Off** in the setup menu (📖54) when using a tripod to stabilize the camera during shooting.

To View a Description (Help Display) of Each Scene

Select a scene and move the zoom control (📖1) toward **T** (👉) to view a description of that scene. To return to the previous screen, move the zoom control toward **T** (👈) again.

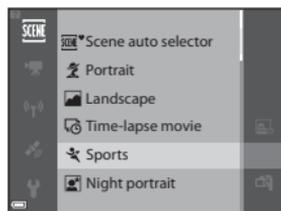

Smart Portrait Mode (Enhancing Human Faces When Shooting)

You can take a picture with the glamour retouch function to enhance human faces.

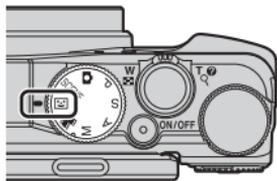

1 Press the multi selector ►.



2 Apply an effect.

- Use ◀▶ to select the desired effect.
- Use ▲▼ to select the amount of effect.
- You can simultaneously apply multiple effects.
☑ **Skin softening**, ☑ **Foundation makeup**, ○ **Soft**, ⊕ **Vividness**, ☑ **Brightness (Exp. +/-)**
- Select ✕ **Exit** to hide the slider.
- After configuring the desired effects, press the OK button to apply them.

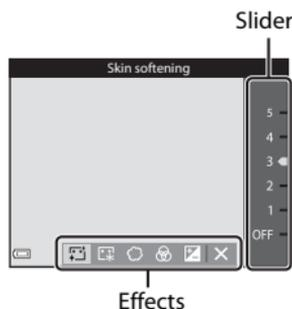

3 Frame the picture and press the shutter-release button.

✓ Notes About Smart Portrait Mode

The amount of effect may differ between the image on the shooting screen and the saved image.

Functions Available in Smart Portrait Mode

- Glamour retouch (📖25)
- Smile timer (📖26)
- Self-Collage (📖27)
- Flash mode (📖35)
- Self-timer (📖37)
- Smart portrait menu (📖50)

Using Smile Timer

When you press the multi selector ◀ to select  **Smile timer** and press the  button, the camera automatically releases the shutter whenever a smiling face is detected.

- Set the glamour retouch function before selecting smile timer (📖25).
- When you press the shutter-release button to take a picture, smile timer is terminated.

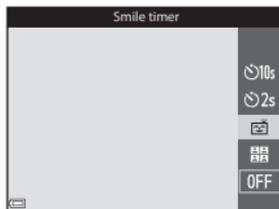

Notes About Smile Timer

- Under some shooting conditions, the camera may be unable to detect faces or smiles (🔑16). The shutter-release button can also be used for shooting.
- This function may not be available to use in combination with other functions (📖44).

When the Self-timer Lamp Flashes

When using smile timer, the self-timer lamp flashes when the camera detects a face and flashes quickly immediately after the shutter is released.

Using Self-Collage

The camera can capture a series of 4 or 9 images at intervals and save them as a one-frame image (a collage image).



1 Press the multi selector ◀ to select **Self-Collage**, and press the **OK** button.

- A confirmation dialog is displayed.
- When you press the **MENU** button and select **Self-Collage** before pressing ◀, you can configure the settings for **Number of shots**, **Interval**, and **Shutter sound** (📖50).
- If you want to apply glamour retouch when shooting, set the effect before selecting self-collage (📖25).

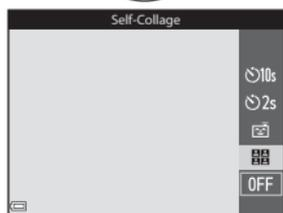

2 Take a picture.

- When you press the shutter-release button, a countdown starts (about five seconds) and the shutter is automatically released.
- The camera automatically releases the shutter for the remaining pictures. A countdown starts about three seconds before shooting.
- The number of shots is indicated by ○ in the monitor. It is displayed in green during shooting and it changes to white after shooting.
- When the camera finishes taking the specified number of shots, the collage image is saved.
- Each captured image is saved as an individual image separate from the collage image.



✓ **Notes About Self-Collage**

- If you press the shutter-release button before the camera takes the specified number of shots, shooting is canceled and the collage image is not saved. The pictures that were taken before shooting was canceled are saved as individual images.
- This function may not be available to use in combination with other functions (📖44).

Short Movie Show Mode (Combining Movie Clips to Create Short Movies)

You can create a short movie (1080P 1080/30p or 1080i 1080/25p) that is up to 30 seconds long by recording and automatically combining multiple movie clips that are several seconds long.

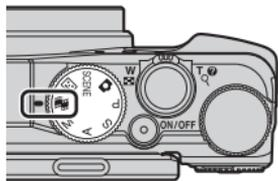

1 Press the MENU (menu) button and configure the settings for recording movies.

- **Number of shots:** Set the number of movie clips that the camera records and the recording time for each movie clip. By default, the camera records 15 movie clips that are 2 seconds each to create a 30-second short movie.
- **Special effects:** Apply various effects to movies when shooting (808). Effects can be changed for each movie clip.
- **Background music:** Select the background music. Move the zoom control (1) toward T (Q) to preview it.
- After the settings are complete, press the MENU button or shutter-release button to exit the menu.

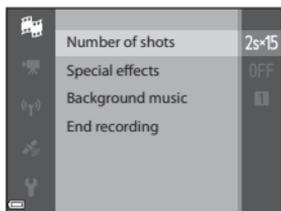

2 Press the (movie-record) button to record a movie clip.

- The camera stops recording the movie clip when the time specified in step 1 elapses.
- Movie clip recording can be paused temporarily. See "Pausing Movie Recording" (30).



3 Check the recorded movie clip, or delete it.

- To check it, press the OK button.
- To delete it, press the button. The last recorded movie clip or all movie clips can be deleted.
- To continue recording movie clips, repeat the operation in step 2.
- To change the effects, return to step 1.

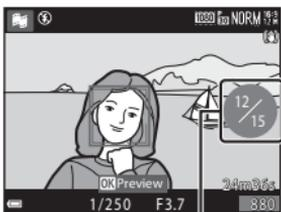

Number of movie clips recorded

4 Save the short movie show.

- The short movie show is saved when the camera finishes recording the specified number of movie clips.
- To save a short movie show before the camera finishes recording the specified number of movie clips, press the **MENU** button on the shooting screen while a movie clip is not being recorded, and then select **End recording**.
- Movie clips are deleted when a short movie show is saved.

Operations During Movie Clip Playback

To adjust the volume, move the zoom control while a movie clip is playing (📖1).

Playback controls are displayed in the monitor.

The operations described below can be performed by using the multi selector  to select a control and then pressing the **OK** button.



Playback controls

Function	Icon	Description
Rewind		Hold down the OK button to rewind the movie.
Advance		Hold down the OK button to advance the movie.
Pause		Pause playback. The operations listed below can be performed while paused.
		 Rewind the movie one frame. Hold down the OK button for continuous rewinding.
		 Advance the movie one frame. Hold down the OK button for continuous advancing.
		Resume playback.
End playback		Return to the shooting screen.
End recording		Save the short movie show using the recorded movie clips.

Notes About Recording a Short Movie Show

- The camera cannot record movies if a memory card is not inserted.
- Do not exchange the memory card until a short movie show is saved.



Pausing Movie Recording

- A still image with **Normal** in image quality and $\frac{199}{12M}$ **4608×2592** in image size can be captured if you press the shutter-release button on the shooting screen while a movie is not being recorded.
- You can pause movie recording and play back images or enter other shooting modes to take pictures. Movie recording resumes when you enter  (short movie show) mode again.

Functions Available in Short Movie Show Mode

- Self-timer (37)
- Macro mode (39)
- Exposure compensation (43)
- Movie options menu (51)

P, S, A, M Modes (Setting the Exposure for Shooting)

Images can be shot with greater control by setting the shutter speed or aperture value manually. Settings can also be adjusted to suit the shooting conditions and the type of shot you want to capture.

- You can change how the camera selects the area of the frame to focus on by changing the **AF area mode** setting (☞50).

When **Target finding AF** (default setting) is used, the camera detects the main subject and focuses on it. If a human face is detected, the camera automatically sets focus priority on it.

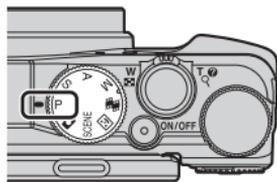

Rotate the command dial or multi selector to set the shutter speed and aperture value.

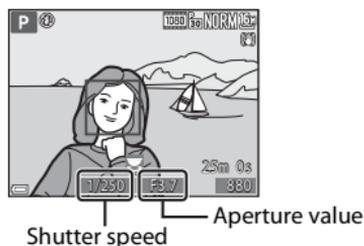
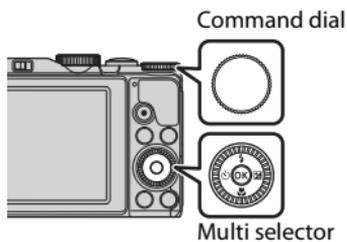

Exposure mode	Shutter speed	Aperture value
P Programmed auto (☞33)	Automatically adjusted (flexible program is enabled by the command dial or multi selector).	
S Shutter-priority auto (☞33)	Adjusted by the command dial or multi selector.	Automatically adjusted.
A Aperture-priority auto (☞33)	Automatically adjusted.	Adjusted by the command dial or multi selector.
M Manual (☞33)	Adjusted by the command dial.	Adjusted by the multi selector.

Exposure

The procedure for shooting images at the desired brightness (exposure) by adjusting the shutter speed or aperture value is called “determine exposure”. The sense of dynamism and amount of background defocus in images to be shot vary depending on the combinations of shutter speed and aperture value even if the exposure is the same.

Adjusting the Shutter Speed



Faster 1/1000 s



Slower 1/30 s

Adjusting the Aperture Value



Larger aperture (Small f-number)
f/3.7



Smaller aperture (Large f-number)
f/8



The Control Range of the Shutter Speed

The control range of the shutter speed differs depending on the zoom position, aperture, or the ISO sensitivity setting.



Aperture Value (F-number) and Zoom

Large apertures (expressed by small f-numbers) let more light into the camera, and small apertures (large f-numbers) let less light.

The aperture value of the zoom lens of this camera changes depending on the zoom position.

P (Programmed auto)

Use for automatic control of the exposure by the camera.

- Different combinations of shutter speed and aperture value can be selected without changing the exposure by rotating the command dial or multi selector (“flexible program”). While flexible program is in effect, a flexible program mark (**X**) is displayed next to the mode indicator (**P**) in the upper left of the monitor.
- To cancel flexible program, rotate the command dial or multi selector until the flexible program mark (**X**) is no longer displayed. Selecting another shooting mode, or turning off the camera, also cancels flexible program.



S (Shutter-priority auto)

Use to shoot fast moving subjects at a fast shutter speed, or use to emphasize the movements of a moving subject at a slow shutter speed.

- The shutter speed can be adjusted by rotating the command dial or multi selector.



A (Aperture-priority auto)

Use to bring subjects including both the foreground and background into focus or blur the subject's background intentionally.

- The aperture value can be adjusted by rotating the command dial or multi selector.



M (Manual)

Use to control the exposure according to shooting requirements.

- When adjusting the aperture value or shutter speed, the degree of deviation from the exposure value measured by the camera is displayed in the exposure indicator of the monitor. The degree of deviation in the exposure indicator is displayed in EVs (-2 to +2 EV in increments of 1/3 EV).
- The shutter speed can be adjusted by rotating the command dial and the aperture value can be adjusted by rotating the multi selector.

Exposure indicator



Notes About Shooting

- When zooming is performed after the exposure is set, exposure combinations or aperture value may be changed.
- When the subject is too dark or too bright, it may not be possible to obtain the appropriate exposure. In such cases, the shutter speed indicator or aperture value indicator flashes (in **P**, **S**, and **A** modes), or the exposure indicator is displayed in red (in **M** mode) when the shutter-release button is pressed halfway. Change the shutter speed setting or aperture value.

Notes About ISO Sensitivity

When **ISO sensitivity** ( 49) is set to **Auto** (default setting), **ISO 125-400** or **ISO 125-800**, the ISO sensitivity in **M** mode is fixed at ISO 125.

Functions Available in P, S, A, M Modes

- Flash mode ( 35)
- Self-timer ( 37)
- Macro mode ( 39)
- Creative slider ( 40)
- Shooting menu ( 49)

Flash Mode

When the flash is raised, you can set the flash mode to match the shooting conditions.

1 Move the ⚡ (flash pop-up) control to raise the flash.

- When the flash is lowered, flash operation is disabled and Ⓜ is displayed.

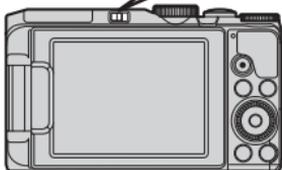
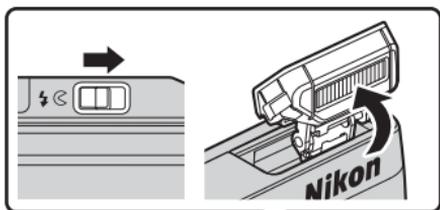

2 Press the multi selector ▲ (⚡).



3 Select the desired flash mode (see 36) and press the OK button.

- If the setting is not applied by pressing the OK button within a few seconds, the selection will be canceled.

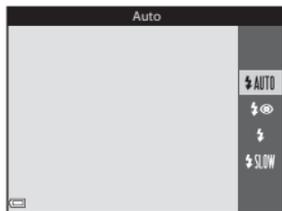

Available Flash Modes

AUTO Auto

The flash fires when necessary, such as in dim lighting.

- The flash mode icon on the shooting screen is displayed only immediately after the setting is made.
- Not available in shooting modes **P**, **S**, **A**, and **M**, and in some scene modes.

Auto with red-eye reduction/Red-eye reduction

Reduce “red-eye” in portraits caused by the flash.

- Red-eye reduction is used in shooting modes **P**, **S**, **A**, and **M** to fire the flash whenever a picture is taken.

Fill flash/Standard flash

The flash fires whenever a picture is taken.

- **Standard flash** is displayed in shooting modes **P**, **S**, **A**, and **M**.

SLOW Slow sync

Suited to evening and night portraits that include background scenery.

The flash fires when necessary to illuminate the main subject; slow shutter speeds are used to capture background at night or under dim lighting.

- Not available in shooting modes **S** and **M**, and in some scene modes.

The Flash Mode Setting

- With some shooting modes, the selectable flash modes may vary, or the flash mode settings may not be available.
- For shooting modes **P**, **S**, **A** and **M**, the setting is saved in the camera’s memory even after the camera is turned off.

Auto with Red-eye Reduction/Red-eye Reduction

Pre-flashes are fired repeatedly at low intensity before the main flash, reducing the red-eye effect. If the camera detects red-eye while saving an image, the affected area is processed to reduce red-eye before the image is saved.

Note the following when shooting:

- Because pre-flashes are fired, there is a slight lag between when the shutter-release button is pressed and when the image is shot.
- More time than usual is required to save images.
- Red-eye reduction may not produce the desired results in some situations.
- In rare cases, red-eye reduction may be applied unnecessarily to other areas of the image. In these cases, select another flash mode and take the picture again.

Self-timer

The camera is equipped with a self-timer that releases the shutter about 10 seconds or 2 seconds after you press the shutter-release button. Set **Photo VR** to **Off** in the setup menu (📖54) when using a tripod to stabilize the camera during shooting.

1 Press the multi selector ◀ (🕒).



2 Select 🕒 10s or 🕒 2s, and press the OK button.

- 🕒 10s (10 seconds): Use on important occasions, such as weddings.
- 🕒 2s (2 seconds): Use to prevent camera shake.
- If the setting is not applied by pressing the OK button within a few seconds, the selection will be canceled.
- When the shooting mode is **Pet portrait** scene mode, 🐾 (pet portrait auto release) is displayed (📖67). The self-timer cannot be used.
- When the shooting mode is smart portrait mode, 📷 (smile timer) or 📷 (self-collage) can also be selected (📖25).

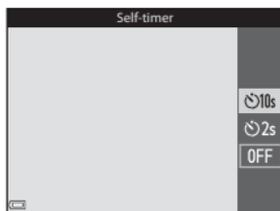

3 Frame the picture and press the shutter-release button halfway.

- Focus and exposure are set.

4 Press the shutter-release button the rest of the way down.

- Countdown starts. The self-timer lamp flashes and then glows steadily about one second before the shutter is released.
- When the shutter is released, the self-timer is set to **OFF**.
- To stop the countdown, press the shutter-release button again.

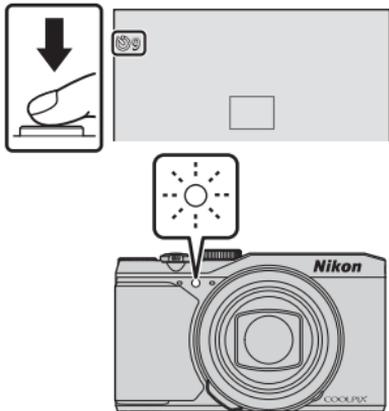

Macro Mode (Taking Close-up Pictures)

Use macro mode when taking close-up pictures.

- 1 Press the multi selector ▼ (🌸).



- 2 Select **ON** and press the **OK** button.

- If the setting is not applied by pressing the **OK** button within a few seconds, the selection will be canceled.

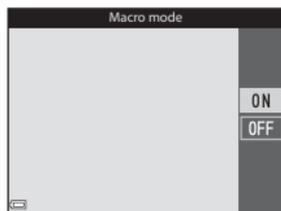

- 3 Move the zoom control to set the zoom ratio to a position where 🌸 and the zoom indicator are displayed in green.



- When the zoom ratio is set to a position where the zoom indicator is displayed in green, the camera can focus on subjects as close as approximately 10 cm (4 in.) from the lens.
When the zoom is at the position where 🌸 is displayed, the camera can focus on subjects as close as approximately 1 cm (0.4 in.) from the lens.

✓ Notes About Using the Flash

The flash may be unable to light the entire subject at distances of less than 50 cm (1 ft 8 in.).

📎 The Macro Mode Setting

- The setting may not be available with some shooting modes (👁️14).
- If the setting is applied in **P**, **S**, **A** or **M** mode, it will remain saved in the camera's memory even after the camera is turned off.

Creative Slider (Adjusting Brightness (Exposure Compensation), Vividness, and Hue)

When the shooting mode is set to **P**, **S**, **A**, or **M** mode, use the creative slider to adjust brightness (exposure compensation), vividness, and hue for capturing images.

- 1 Press the multi selector .



- 2 Select the item and make an adjustment.

-  : Select an item.
 - : "Brightness (Exposure Compensation)" (41)
 - : "Vividness (Saturation Adjustment)" (42)
 - : "Hue (White Balance Adjustment)" (42)

-   or rotation: The slider moves. The effect can be adjusted while confirming the results on the monitor.
- To turn off the effects of the creative slider, select **R** and press the  button.

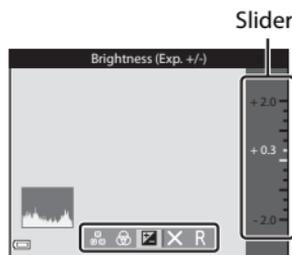

- 3 When adjustment is complete, select  and press the  button.

- If the  button (except when **R** is selected) or the shutter-release button is pressed in step 2, the selected amount of effect is applied. When the effect is applied, the camera returns to the shooting screen.



Creative Slider Settings

The settings for Brightness (Exp. +/-), Vividness and Hue are saved in the camera's memory even after the camera is turned off.

Brightness (Exposure Compensation)

Adjust the overall brightness of the image.

- To brighten the image, set a positive (+) value.
- To darken the image, set a negative (-) value.

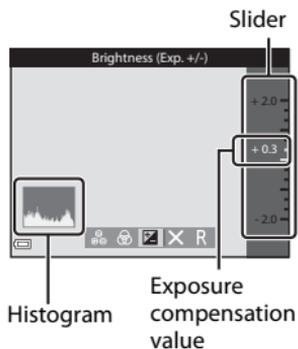

✓ Notes About Exposure Compensation

Brightness adjustment (exposure compensation) cannot be used in **M** mode.

📎 Using the Histogram

A histogram is a graph showing the distribution of tones in the image. Use as a guide when using exposure compensation and shooting without the flash.

- The horizontal axis corresponds to pixel brightness, with dark tones to the left and bright tones to the right. The vertical axis shows the number of pixels.
- Increasing exposure compensation shifts tone distribution to the right, and decreasing it shifts tone distribution to the left.

Vividness (Saturation Adjustment)

Adjust the overall vividness of the image.

- The overall image vividness increases as the slider is moved up. The overall image vividness decreases as the slider is moved down.

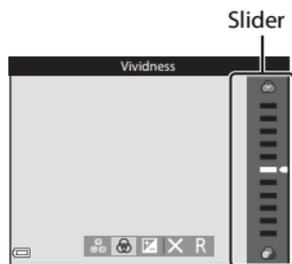

Hue (White Balance Adjustment)

Adjust the overall hue of the image.

- The overall image becomes more reddish as the slider is moved up. The overall image becomes more bluish as the slider is moved down.

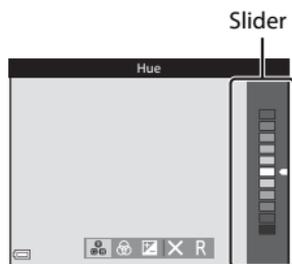

Notes About Hue Adjustment

This function may not be available to use in combination with other functions (📷14).

Exposure Compensation (Adjusting Brightness)

When the shooting mode is set to  (auto) mode, scene mode, or short movie show mode, you can adjust the brightness (exposure compensation).

- 1 Press the multi selector .



- 2 Select a compensation value and press the  button.

- To brighten the image, set a positive (+) value.
- To darken the image, set a negative (-) value.
- The compensation value is applied, even without pressing the  button.

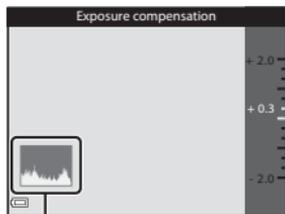

Histogram

Exposure Compensation Value

- The setting may not be available with some shooting modes ( 14).
- When the exposure compensation is set while using the flash, the compensation is applied to both the background exposure and to the flash output.

Functions That Cannot Be Used Simultaneously When Shooting

Some functions cannot be used with other menu options.

Restricted function	Option	Description
Flash mode	Continuous (📖49)	When a setting other than Single is selected, the flash cannot be used.
	Blink proof (📖50)	When Blink proof is set to On , the flash cannot be used.
Self-timer	AF area mode (📖50)	When Subject tracking is selected, the self-timer cannot be used.
Macro mode	AF area mode (📖50)	When Subject tracking is selected, macro mode cannot be used.
Image quality	Continuous (📖49)	When Pre-shooting cache , Continuous H: 120 fps , or Continuous H: 60 fps is selected, the setting is fixed at Normal .
Image size	Continuous (📖49)	<p>Image size is set as follows depending on the continuous shooting setting:</p> <ul style="list-style-type: none"> • Pre-shooting cache:  (image size: 1280 × 960 pixels) • Continuous H: 120 fps:  640×480 • Continuous H: 60 fps:  (image size: 1280 × 960 pixels)
White balance	Hue (using the creative slider) (📖42)	When hue is adjusted using the creative slider, White balance in the shooting menu cannot be set. To set White balance , select R in the creative slider setting screen to reset the brightness, vividness, and hue.

Restricted function	Option	Description
Continuous	Self-timer (📖37)	If the self-timer is used when Pre-shooting cache is selected, the setting is fixed at Single .
ISO sensitivity	Continuous (📖49)	When Pre-shooting cache , Continuous H: 120 fps , or Continuous H: 60 fps is selected, the ISO sensitivity setting is automatically specified according to the brightness.
AF area mode	White balance (📖49)	When a setting other than Auto is selected for White balance in Target finding AF mode, the camera does not detect the main subject.
Self-Collage	Blink proof (📖50)	When Blink proof is set to On , Self-Collage cannot be used.
Blink proof	Self-Collage (📖27)	When Self-Collage is set, Blink proof cannot be used.
Date stamp	Continuous (📖49)	When Continuous H , Continuous L , Pre-shooting cache , Continuous H: 120 fps , or Continuous H: 60 fps is selected, date and time cannot be stamped on images.
	Blink proof (📖50)	When Blink proof is set to On , date and time cannot be stamped on images.

Restricted function	Option	Description
Photo VR	Flash mode (📖35)	If the flash fires when On (hybrid) is selected, the setting is fixed at On .
	Self-timer (📖37)	If the self-timer is used when On (hybrid) is selected, the setting is fixed at On .
	Continuous (📖49)	If Continuous is set to any setting other than Single when On (hybrid) is selected, the setting is fixed at On .
	ISO sensitivity (📖49)	If ISO sensitivity is set to Fixed range auto or ISO 400 or higher when On (hybrid) is selected, the setting is fixed at On .
Digital zoom	AF area mode (📖50)	When Subject tracking is selected, digital zoom cannot be used.
Shutter sound	Continuous (📖49)	When a setting other than Single is selected, the shutter sound is disabled.

✔ Notes About Digital Zoom

- Depending on the shooting mode or the current settings, digital zoom may not be available (📷101).
- When digital zoom is in effect, the camera focuses in the center of the frame.

Functions That Can Be Set with the MENU (Menu) Button

You can set the menus listed below by pressing the **MENU** (menu) button.

- **📷, SCENE, 😊, 📷, P, S, A, M Shooting menu**
 Available by pressing the **MENU** button when the shooting screen is displayed.
 Allows you to change image size and quality, continuous shooting settings, etc.
 Menu icons and setting items vary depending on the shooting mode.
- **🎬 Movie menu**
 Available by pressing the **MENU** button when the shooting screen is displayed.
 Allows you to change movie recording settings.
- **▶ Playback menu/📅 List by date menu**
 Available by pressing the **MENU** button when viewing images in full-frame playback mode or thumbnail playback mode.
 Allows you to edit images, play slide shows, etc.
- **📍 Location data options menu**
 Allows you to configure location data options.
 When **Record location data** in **Location data options** is set to **On**, the camera starts receiving signals from the positioning satellites.
- **(T) Wi-Fi options menu**
 Allows you to configure Wi-Fi settings for connecting the camera and a smart device.
- **🔧 Setup menu**
 Allows you to adjust basic camera functions such as date and time, display language, etc.

1 Press the MENU (menu) button.

- The menu is displayed.



2 Press the multi selector ◀.

- The current menu icon is displayed in yellow.

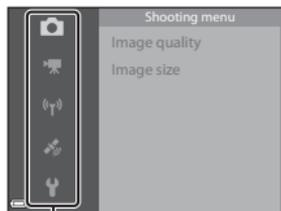

Menu icons

3 Select a menu icon and press the OK button.

- The menu options become selectable.

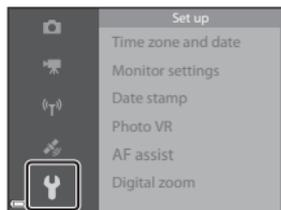

4 Select a menu option and press the OK button.

- Certain menu options cannot be set depending on the current shooting mode or the state of the camera.

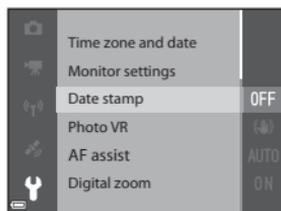

5 Select a setting and press the OK button.

- The setting you selected is applied.
- When you are finished using the menu, press the MENU button.
- When a menu is displayed, you can switch to shooting mode by pressing the shutter-release button or (shutter-release button) button.

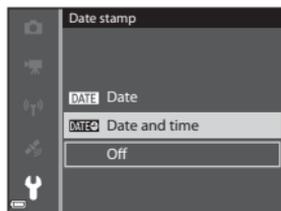

Command Dial or Multi Selector Operation When a Menu is Displayed

When a menu or setting items are displayed, you can select a menu option also by rotating the command dial or multi selector.

The Shooting Menu

Enter shooting mode → MENU button

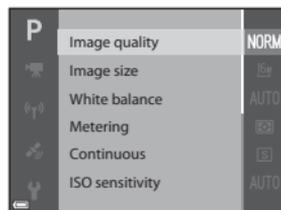

Common Options

Option	Description	
Image quality	Allows you to set the image quality (compression ratio) used when saving images. <ul style="list-style-type: none">• Default setting: Normal	60
Image size	Allows you to set the image size used when saving images. <ul style="list-style-type: none">• Default setting: 4608x3456	61

For P, S, A, M modes

Option	Description	
White balance	Allows you to adjust white balance to suit the weather conditions or light source in order to make the colors in images match what you see with your eyes. <ul style="list-style-type: none">• Default setting: Auto	62
Metering	Allows you to set the method that the camera uses to measure the brightness of the subject. <ul style="list-style-type: none">• Default setting: Matrix	64
Continuous	Allows you to select single or continuous shooting. <ul style="list-style-type: none">• Default setting: Single	65
ISO sensitivity	Allows you to control the camera's sensitivity to light. <ul style="list-style-type: none">• Default setting: Auto When Auto is selected, is displayed in the monitor while shooting if ISO sensitivity increases.	68

Option	Description	
AF area mode	Allows you to determine how the camera selects the focus area that is used for autofocus. <ul style="list-style-type: none"> • Default setting: Target finding AF ( 18) 	 69
Autofocus mode	Allows you to set the method how the camera focuses. <ul style="list-style-type: none"> • Default setting: Pre-focus 	 72
M exposure preview	Allows you to select whether or not changes in the brightness are also reflected on the shooting screen when the exposure is changed in M (manual) mode. <ul style="list-style-type: none"> • Default setting: On 	 72

For Smart Portrait mode

Option	Description	
Self-Collage	Allows you to select the number of shots, interval, and shutter sound of interval timer shooting. <ul style="list-style-type: none"> • Default setting: <ul style="list-style-type: none"> - Number of shots: 4 - Interval: Medium - Shutter sound: Magic 	 73
Blink proof	The camera automatically releases the shutter twice with every shot and saves one image in which the subject's eyes are open. <ul style="list-style-type: none"> • Default setting: Off 	 74

The Movie Menu

Enter shooting mode → MENU button →  menu icon →  button

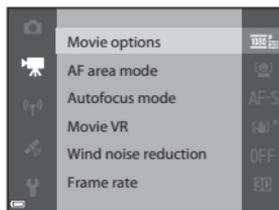

Option	Description	
Movie options	Select the movie type. Select normal speed to record movies at normal speed, or HS (high speed) to record movies that play in slow or fast motion. • Default setting:  1080/30p or  1080/25p	 75
AF area mode	Set the method how the camera selects the focus area for autofocus during movie recording. • Default setting: Face priority	 79
Autofocus mode	Select either Single AF , which locks focus when movie recording begins, or Full-time AF , which continues focusing during movie recording. • Default setting: Single AF	 80
Movie VR	Select the vibration reduction setting used when recording movies. • Default setting: On (hybrid)	 81
Wind noise reduction	Set whether or not to reduce wind noise during movie recording. • Default setting: Off	 81
Frame rate	Select the frame rate used when recording movies.	 82

The Playback Menu

Press the  button (playback mode) → MENU button

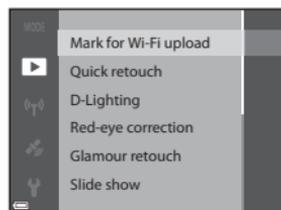

Option	Description	
Mark for Wi-Fi upload	Allows you to select images in the camera that you want to transfer to a smart device in advance before transferring them.	 82
Quick retouch*	Allows you to create retouched copies in which contrast and saturation have been enhanced.	 27
D-Lighting*	Allows you to create copies with enhanced brightness and contrast, brightening dark portions of an image.	 27
Red-eye correction*	Corrects “red-eye” that may occur in images when shooting with a flash.	 28
Glamour retouch*	Detects faces in images and retouches the detected faces glamorously.	 28
Slide show	Allows you to view images in an automated slide show.	 83
Protect	Protects selected images from accidental deletion.	 84
Rotate image	Allows you to rotate the displayed image to portrait or landscape orientation.	 84
Small picture*	Creates a small copy of images.	 30
Copy	Allows you to copy images between the internal memory and a memory card.	 85

Option	Description	
Sequence display options	<p>Allows you to select whether to display only the key picture for a sequence of images captured continuously or to display the sequence as individual images.</p> <ul style="list-style-type: none"> When only the key picture is displayed for a sequence, press the OK button to display each image in the sequence. Press the multi selector ▲ to return to the key picture display. 	 86

* Edited images are saved as separate files. Some images may not be edited.

The Image Selection Screen

When an image selection screen such as the one shown on the right is displayed while operating the camera, follow the procedures described below to select the images.



1 Use the multi selector **◀▶** to select an image.

- Move the zoom control ( 1) toward **T** () to switch to full-frame playback or **W** () to switch to thumbnail playback.
- Only one image can be selected for **Rotate image**. Proceed to step 3.



2 Use **▲▼** to select or deselect.

- When an image is selected, an icon is displayed below the image. Repeat steps 1 and 2 to select additional images.



3 Press the **OK** button to apply image selection.

- When a confirmation dialog is displayed, follow the on-screen instructions to operate.

The Setup Menu

Press the **MENU** button →  menu icon →  button

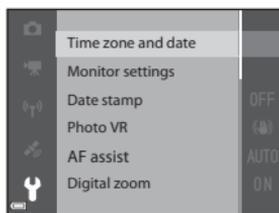

Option	Description	
Time zone and date	Allows you to set the camera clock.	 95
Monitor settings	Allows you to adjust photo information display, post-shooting image review, and monitor brightness settings.	 97
Date stamp	Allows you to imprint the shooting date and time on images.	 99
Photo VR	Allows you to select the vibration reduction setting used when shooting still images.	 100
AF assist	Allows you to enable or disable the AF-assist illuminator.	 101
Digital zoom	Allows you to enable and disable digital zoom.	 101
Sound settings	Allows you to adjust sound settings.	 102
Auto off	Allows you to set the amount of time that passes before the monitor turns off to save power.	 102
Format card/ Format memory	Allows you to format the memory card or internal memory.	 103
Language	Allows you to change the camera's display language.	 103
Charge by computer	Allows you to set whether or not the battery in the camera is charged when the camera is connected to a computer.	 104
Reset all	Allows you to reset the camera's settings to their default values.	 105
Conformity marking	View some of the conformity markings that the camera complies with.	 105
Firmware version	View the current camera firmware version.	 105

Using Location Data Functions/ Displaying Maps

Select the  (location data options) menu (47), and set **Record location data** in **Location data options** to **On**, the camera starts receiving signals from positioning satellites.

Location data reception can be checked on the shooting screen.

-  or : Signals are being received from four or more satellites, or from three satellites, and positioning is being performed.
- : Signals are being received, but positioning is not possible.
- : Signals are not received.



Recording the Shooting Location Data on the Image

- When shooting while positioning is being performed, the obtained location data (latitude and longitude) are recorded on the images to be shot.
- When **Compass display** in **Electronic compass** is set to **On**, a rough direction of the shooting is also recorded.

Recording the Log

- When selecting **Start log** in **Create log** in the location data options menu, while positioning is being performed, the location data of places you visit with the camera is recorded at the certain interval.
- The recorded log (location data) can be displayed on the map, when you store the log on the memory card and then select **View log** in the location data options menu. To save the recorded log, end log recording in **Create log** and select **Save log**.

Displaying Maps

- To display the current position on the map if positioning is being performed, press the  (map) button on the shooting screen.
- To display the shooting location on the map, play back the images which have the location data recorded, and press the  button.



Using the Wi-Fi (Wireless LAN) Function

You can perform the following functions if you install the dedicated software “Wireless Mobile Utility” on your smart device that runs on Android OS or iOS, and connect it to the camera.

Take Photos

You can capture still images using the two methods described below.

- Release the shutter on the camera and save the captured images to a smart device.
- Use a smart device to remotely release the camera shutter and save images to the smart device.

View Photos

Images that are saved in the camera’s memory card can be transferred and viewed on your smart device. You can also preselect the images in the camera that you want to transfer to your smart device.

Notes About Security Settings

No security settings such as password are configured for the camera at the time of purchase. We strongly recommend performing the required security settings before using the Wi-Fi function. Use **Options** in the Wi-Fi options menu (📖47) to perform the security settings.

Installing the Software on the Smart Device

1 Use your smart device to connect to the Google Play Store, App Store or other online apps marketplace and search for “Wireless Mobile Utility.”

- Check the user’s manual provided with your smart device for further details.

2 Check the description and other information and install the software.

User’s Manual for Wireless Mobile Utility

Download the user’s manual from the website below.

- Android OS: <http://nikonimglib.com/ManDL/WMAU/>
- iOS: <http://nikonimglib.com/ManDL/WMAU-ios/>

To establish a connection with the camera, press the  (Wi-Fi) button on the camera, and turn on the Wi-Fi function of the smart device, and then start the “Wireless Mobile Utility” while **Negotiating... Please wait.** is displayed on the camera.

Connecting the Camera to a TV, Printer, or Computer

You can enhance your enjoyment of images and movies by connecting the camera to a TV, printer, or computer.

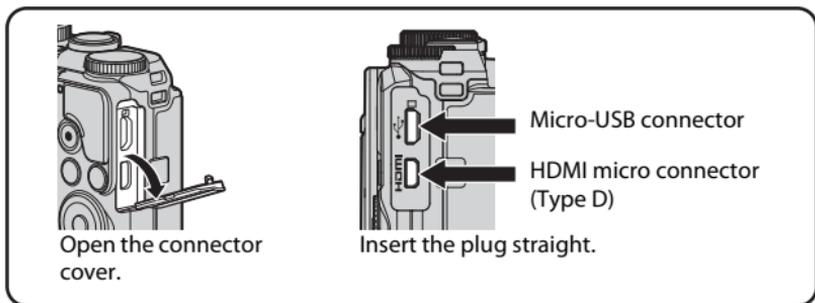

- Before connecting the camera to an external device, make sure the remaining battery level is sufficient and turn the camera off. Before disconnecting, make sure to turn the camera off.
- If the AC Adapter EH-62F (available separately) is used, this camera can be powered from an electrical outlet. Do not use any other make or model of AC adapter as it may cause the camera to heat up or malfunction.
- For information about the connection methods and subsequent operations, refer to the documentation included with the device in addition to this document.

Viewing images on a TV

 53



Images and movies captured with the camera can be viewed on a TV.

Connection method: Connect a commercially available HDMI cable to the TV's HDMI input jack.

Printing images without using a computer

 54



If you connect the camera to a PictBridge-compatible printer, you can print images without using a computer.

Connection method: Connect the camera directly to the printer's USB port with the USB cable.

Viewing and organizing images on a computer

 58



You can transfer images to a computer to perform simple retouching and manage image data.

Connection method: Connect the camera to the computer's USB port with the USB cable.

- Before connecting to a computer, install ViewNX 2 on the computer ( 58).
- If any USB devices that draw the power from the computer are connected, disconnect them from the computer before you connect the camera to it. Connecting the camera and other USB-powered devices to the same computer simultaneously may cause a camera malfunction or excessive power supply from the computer, which could damage the camera or memory card.



Reference Section

The Reference Section provides detailed information and hints about using the camera.

Shooting

Tips and Notes on the Scene Mode.....	03
Default Settings (Flash, Self-timer, Etc.).....	14
Focusing.....	16
The Control Range of the Shutter Speed (P, S, A, or M Modes).....	20

Playback

Playback Zoom	21
Thumbnail Playback/Calendar Display	22
List by Date Mode	23
Viewing and Deleting Images Captured Continuously (Sequence).....	24
Editing Images (Still Images).....	26

Location Data Functions/Map Display

Recording the Location Data on the Image	32
Displaying the Shooting Location on the Map (While in Playback Mode)	35
Displaying the Current Position on the Map (While in Shooting Mode)	38
Recording the Log of Movement Information	39
Viewing the Log of Location Data on the Map	42

Movies

Recording and Playing Back Movies	43
Capturing Still Images While Recording Movies	46
Operations During Movie Playback	47
Editing Movies	48

Connection

Connecting to a Smart Device (Wi-Fi)	 50
Preselecting Images in the Camera That You Want to Transfer to a Smart Device	 52
Connecting the Camera to a TV (Playback on a TV)	 53
Connecting the Camera to a Printer (Direct Print).....	 54
Using ViewNX 2 (Transferring Images to a Computer)	 58

Menu

The Shooting Menu (The Common Shooting Options).....	 60
The Shooting Menu (P, S, A, or M Mode)	 62
The Smart Portrait Menu	 73
The Movie Menu.....	 75
The Playback Menu	 82
The Location Data Options Menu	 87
The Wi-Fi Options Menu.....	 93
The Setup Menu	 95

Additional Information

Error Messages.....	 106
File Names	 111
Optional Accessories	 112

Tips and Notes on the Scene Mode

SCENE → Scene auto selector

- When you point the camera at the subject, the camera automatically recognizes the optimum scene mode from the list below and adjusts the shooting settings accordingly.

	Portrait (for taking close-up portraits of one or two people)
	Portrait (for taking portraits of large numbers of people, or images in which the background takes up a large portion of the frame)
	Landscape
	Night portrait (for taking close-up portraits of one or two people)
	Night portrait (for taking portraits of large numbers of people, or images in which the background takes up a large portion of the frame)
	Night landscape
	Close-up
	Backlighting (for taking pictures of subjects other than people)
	Backlighting (for taking portrait pictures)
	Other scenes

- The focus area depends on the composition of the image. When the camera detects a human face, it focuses on that face (16).
- Depending on shooting conditions, the camera may not select the desired scene mode. In this case, select another shooting mode (20).

SCENE → Sports

- While the shutter-release button is held all the way down, the camera shoots up to about 5 images continuously at a rate of about 7 fps (when image quality is set to **Normal** and when image size is set to  **4608×3456**).
- The frame rate for continuous shooting may become slow depending on the current image quality setting, image size setting, the memory card used, or shooting condition.
- Focus, exposure, and hue are fixed at the values determined with the first image in each series.

SCENE → Night portrait

- On the screen displayed when  **Night portrait** is selected, select  **Hand-held** or  **Tripod**.
-  **Hand-held** (default setting):
 - While the  icon on the shooting screen is displayed in green, press the shutter-release button all the way to capture a series of images which are combined into a single image and saved.
 - Once the shutter-release button is pressed all the way, hold the camera still until a still image is displayed. After taking a picture, do not turn the camera off before the monitor switches to the shooting screen.
 - If the subject moves while the camera is shooting continuously, the image may be distorted, overlapped, or blurred.
-  **Tripod**:
 - One image is captured at a slow shutter speed when the shutter-release button is pressed all the way.
 - Vibration reduction is disabled regardless of the **Photo VR** setting in the setup menu ( 54).

SCENE → Party/indoor

- To avoid the effects of camera shake, hold the camera steady. Set **Photo VR** to **Off** in the setup menu ( 54) when using a tripod to stabilize the camera during shooting.

SCENE → 🌃 Night landscape

- On the screen displayed when 🌃 **Night landscape** is selected, select 📱 **Hand-held** or 📵 **Tripod**.
- 📱 **Hand-held** (default setting):
 - While the 🌃 icon on the shooting screen is displayed in green, press the shutter-release button all the way to capture a series of images which are combined into a single image and saved.
 - Once the shutter-release button is pressed all the way, hold the camera still until a still image is displayed. After taking a picture, do not turn the camera off before the monitor switches to the shooting screen.
 - The angle of view (i.e., the area visible in the frame) seen in the saved image is narrower than that seen in the monitor at the time of shooting.
- 📵 **Tripod**:
 - One image is captured at a slow shutter speed when the shutter-release button is pressed all the way.
 - Vibration reduction is disabled regardless of the **Photo VR** setting in the setup menu (📖54).

SCENE → 🌸 Close-up

- Macro mode (📖39) is enabled and the camera automatically zooms to the closest position at which it can focus.
- You can move the focus area. Press the Ⓞ button, use the multi selector ▲▼◀▶ or rotate it to move the focus area, and press the Ⓞ button to apply the setting.

SCENE → 🍴 Food

- Macro mode (📖39) is enabled and the camera automatically zooms to the closest position at which it can focus.
- You can adjust hue by using the multi selector ▲▼. The hue setting is saved in the camera's memory even after the camera is turned off.
- You can move the focus area. Press the Ⓞ button, use the multi selector ▲▼◀▶ or rotate it to move the focus area, and press the Ⓞ button to apply the setting.



SCENE → Fireworks show

- The shutter speed is fixed at about four seconds.
- The zoom is restricted to 10 fixed positions.

SCENE → Backlighting

- On the screen displayed when  **Backlighting** is selected, select **On** or **Off** of **HDR** (high dynamic range) composition based on the type of image you want to capture.
- **Off** (default setting): The flash fires to prevent the subject from being hidden in shadow.
 - When the shutter-release button is pressed all the way down, one image is captured.
- **On**: Use when taking pictures with very bright and dark areas in the same frame.
 - When the shutter-release button is pressed all the way, the camera shoots images continuously at high speed, and saves the following two images.
 - A non-HDR composite image
 - An HDR composite image in which the loss of details in highlights or shadows is minimized
 - If there is only enough memory to save one image, an image processed by D-Lighting ( 27) at the time of shooting, in which dark areas of the image are corrected, is the only image saved.
 - Once the shutter-release button is pressed all the way, hold the camera still until a still image is displayed. After taking a picture, do not turn the camera off before the monitor switches to the shooting screen.
 - The angle of view (i.e., the area visible in the frame) seen in the saved image is narrower than that seen in the monitor at the time of shooting.

SCENE → 🐾 Pet portrait

- When you point the camera at a dog or cat, the camera detects the pet's face and focuses on it. By default, the shutter is automatically released when the camera detects a dog or cat face (pet portrait auto release).
- On the screen displayed when 🐾 **Pet portrait** is selected, select **[S] Single** or **[📷] Continuous**.
 - **[S] Single**: Whenever the camera detects a dog or cat face, the camera captures 1 image.
 - **[📷] Continuous**: Whenever the camera detects a dog or cat face, the camera captures 3 images continuously.

✔ **Pet Portrait Auto Release**

- Press the multi selector ◀ (🔊) to change the **Pet portrait auto release** settings.
 - **[🔊]**: When the camera detects a dog or cat face, the camera automatically releases the shutter.
 - **OFF**: The camera does not release the shutter automatically, even if a dog or cat face is detected. Press the shutter-release button. The camera also detects human faces when **OFF** is selected.
- **Pet portrait auto release** is set to **OFF** after 5 bursts have been taken.
- Shooting is also possible by pressing the shutter-release button, regardless of the **Pet portrait auto release** setting.

✔ **Focus Area**

- When the camera detects a face, the face is displayed inside a yellow border. When the camera acquires focus on a face displayed inside a double border (focus area), the double border changes to green. If no faces are detected, the camera focuses on the subject in the center of the frame.
- Under some shooting conditions, the pet face may not be detected and other subjects may be displayed inside a border.



SCENE → Special effects

- On the screen displayed when  **Special effects** is selected, select the shooting effect.

Type	Description
SOFT Soft (default setting)	Softens the image by adding a slight blur to the entire image.
SEPIA Nostalgic sepia	Adds a sepia tone and reduces the contrast to simulate the qualities of an old photograph.
 High-contrast mono.	Changes the image to black and white and gives it sharp contrast.
 Selective color	Creates a black and white image in which only the specified color remains.
POP Pop	Increases the color saturation of the entire image to create a bright look.
 Cross process	Gives the image a mysterious appearance based on a specific color.
 Toy camera effect 1	Gives the entire image a yellowish hue and darkens the image periphery.
 Toy camera effect 2	Decreases the color saturation of the entire image and darkens the image periphery.

- When **Selective color** or **Cross process** is selected, use the multi selector  to select the desired color, and press the  button to apply the color. To change the color selection, press the  button again.



Shooting Time-lapse Movies

The camera can automatically capture 300 still images at a specified interval to create time-lapse movies (1080p 1080/30p) that are approximately 10 seconds long.

Rotate the mode dial to **SCENE** → **MENU** button →  Time-lapse movie → **OK** button

Type	Interval time	Recording time
 Cityscape (10 minutes) (default setting)	2 s	10 min
 Landscape (25 minutes)	5 s	25 min
 Sunset (50 minutes)	10 s	50 min
 Night sky (150 minutes) ^{1, 2}	30 s	2 h 30 min
 Star trails (150 minutes) ^{2, 3}	30 s	2 h 30 min

¹ Suited for recording the movement of stars. The focus is fixed at infinity.

² The zoom is restricted to 10 fixed positions.

³ Star movement appears as lines of light due to image processing. The focus is fixed at infinity.

1 Use the multi selector ▲▼ to select a type, and press the **OK** button.

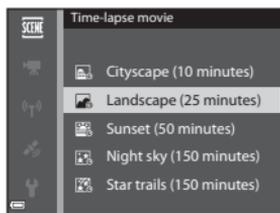

2 Select whether or not to fix exposure (brightness), and press the **OK** button (except Night sky and Star trails).

- If **AE-L on** is selected, the exposure used for the first image is used for all images. Use of **AE-L off** is recommended when the changes in brightness of the subject are significant, such as in the twilight.

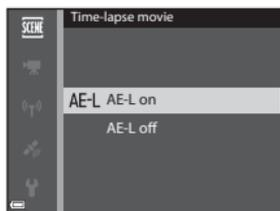

3 Stabilize the camera by using a tool such as a tripod.

4 Press the shutter-release button to capture the first image.

- Set exposure compensation (📖43) before releasing the shutter for the first image. Exposure compensation cannot be changed after the first image is captured. Focus and hue are fixed when the first image is captured.
- The shutter is automatically released for the second and subsequent images.
- The monitor may turn off while the camera is not capturing images.
- Shooting ends automatically when 300 images are captured.
- To end shooting manually before 300 images are captured, press the **OK** button.
- Sound and still images cannot be saved.

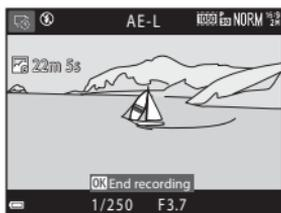

✓ Notes About Time-lapse Movie

- The camera cannot capture images if a memory card is not inserted. Do not exchange the memory card until shooting is complete.
- Use a fully charged battery to prevent the camera from turning off unexpectedly.
- Time-lapse movies cannot be recorded by pressing the **●** (📷) button.
- Do not rotate the mode dial until shooting is complete.
- Vibration reduction is disabled regardless of the **Photo VR** setting in the setup menu (📖54).

Shooting with Easy Panorama

Rotate the mode dial to **SCENE** → **MENU** button → Easy panorama → **OK** button

1 Select **Normal** or **Wide** as the shooting range and press the **OK** button.

- When the camera is readied in the horizontal position, the image size (width × height) is as follows.
 - **Normal:**
4800 × 920 when moved horizontally,
1536 × 4800 when moved vertically
 - **Wide:**
9600 × 920 when moved horizontally,
1536 × 9600 when moved vertically

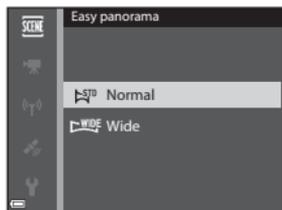

2 Frame the first edge of the panorama scene, and then press the shutter-release button halfway to focus.

- The zoom position is fixed at wide-angle position.
- The camera focuses in the center of the frame.

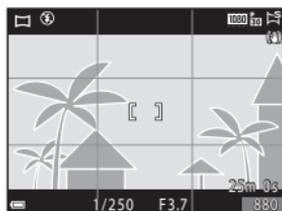

3 Press the shutter-release button all the way, and then remove your finger from the shutter-release button.

- \triangle ∇ \leftarrow \rightarrow are displayed to indicate the direction of camera movement.



4 Move the camera in one of the four directions until the guide indicator reaches the end.

- When the camera detects which direction it is moving in, shooting begins.
- Shooting ends when the camera captures the specified shooting range.
- Focus and exposure are locked until shooting ends.

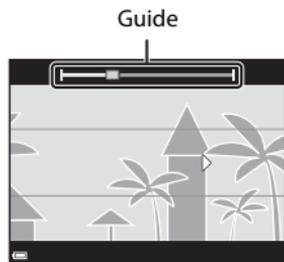

Example of Camera Movement

- Using your body as the axis of rotation, move the camera slowly in an arc, in the direction of the marking (△▽◀▶).
- Shooting stops if the guide does not reach the edge within about 15 seconds (when **Normal** is selected) or within about 30 seconds (when **Wide** is selected) after shooting starts.



✓ Notes About Easy Panorama Shooting

- The range of the image seen in the saved image is narrower than that seen in the monitor at the time of shooting.
- If the camera is moved too quickly or shaken too much, or if the subject is too uniform (e.g. walls or darkness), an error may occur.
- If shooting is stopped before the camera reaches the half-way point in the panorama range, a panorama image is not saved.
- If more than half of the panorama range is captured but shooting ends before reaching the edge of the range, the range not captured is recorded and displayed in gray.

Playback with Easy Panorama

Switch to playback mode (📖18), display an image captured using easy panorama in full-frame playback mode, and then press the **OK** button to scroll the image in the direction that was used when shooting.

- Rotate the multi selector to scroll forward or backward quickly.

Playback controls are displayed at the bottom of the monitor during playback.

Use the multi selector **◀▶** to select a control, and then press the **OK** button to perform the operations described below.

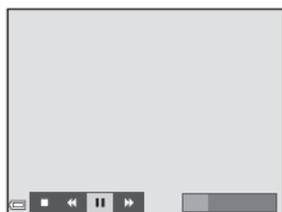
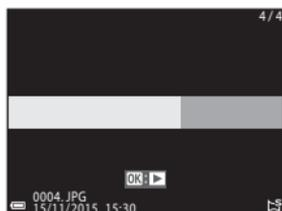

Function	Icon	Description	
Rewind	◀	Hold down the OK button to scroll backward quickly.*	
Advance	▶	Hold down the OK button to scroll forward quickly.*	
Pause	⏸	Pause playback. The operations listed below can be performed while paused.	
		◀	Hold down the OK button to rewind.*
		▶	Hold down the OK button to scroll.*
	▶	Resume automatic scrolling.	
End	■	Switch to full-frame playback mode.	

* These operations can also be performed by rotating the multi selector.

✓ Notes About Easy Panorama Images

- The images cannot be edited on this camera.
- This camera may not be able to scroll the playback of, or zoom in on, easy panorama images captured with another make or model of digital camera.

✓ Notes About Printing Panorama Images

The entire image may not be able to be printed depending on the printer's settings. Additionally, printing may not be possible depending on the printer.

Default Settings (Flash, Self-timer, Etc.)

Default settings for each shooting mode are listed below.

	Flash ( 35)	Self-timer ( 37)	Macro ( 39)	Exposure compensation ( 43)
 (auto)	 AUTO	OFF	OFF	0.0
SCENE				
 (scene auto selector)	 AUTO ¹	OFF	OFF ²	0.0
 (portrait)	 	OFF	OFF ³	0.0
 (landscape)	 ³	OFF	OFF ³	0.0
 (time-lapse movie)	 ³	OFF	OFF ³	0.0 ⁴
 (sports)	 ³	OFF ³	OFF ³	0.0
 (night portrait)	  ³	OFF	OFF ³	0.0
 (party/indoor)	  ⁵	OFF	OFF ³	0.0
 (beach)	 AUTO	OFF	OFF ³	0.0
 (snow)	 AUTO	OFF	OFF ³	0.0
 (sunset)	 ³	OFF	OFF ³	0.0
 (dusk/dawn)	 ³	OFF	OFF ³	0.0
 (night landscape)	 ³	OFF	OFF ³	0.0
 (close-up)	 AUTO	OFF	ON ³	0.0
 (food)	 ³	OFF	ON ³	0.0
 (fireworks show)	 ³	OFF ³	OFF ³	0.0 ³
 (backlighting)	 ⁶ /  ⁶	OFF	OFF ³	0.0
 (easy panorama)	 ³	OFF ³	OFF ³	0.0
 (pet portrait)	 ³	 ⁷	OFF	0.0
 (special effects)	 AUTO	OFF	OFF	0.0
 (smart portrait)	 AUTO ⁸	OFF ⁹	OFF ³	_10
 (short movie show)	 ³	OFF	OFF	0.0
P, S, A, M		OFF	OFF	_11

- 1 Cannot be changed. The camera automatically selects the flash mode appropriate for the scene it has selected.
- 2 Cannot be changed. The camera enters macro mode when  is selected.
- 3 Cannot be changed.
- 4 Cannot be changed when Night sky or Star trails is used.
- 5 May switch to slow sync with red-eye reduction flash mode.
- 6 Flash is fixed at  (fill flash) when **HDR** is set to **Off**, and is fixed at  (off) when **HDR** is set to **On**.
- 7 Self-timer cannot be used. Pet portrait auto release can be set to **ON** or **OFF** ()7).
- 8 Cannot be used when **Blink proof** is set to **On**.
- 9 Other than self-timer,  (smile timer) (26) and  (self-collage) (27) can be also used.
- 10 Glamour retouch is displayed (25).
- 11 Creative slider is displayed (40).

Focusing

The focus area varies depending on the shooting mode.

Using Face Detection

In the following shooting modes, the camera uses face detection to automatically focus on human faces.

-  (Auto) mode (📖22)
- **Scene auto selector**, **Portrait**, or **Night portrait** scene mode (📖23)
- Smart portrait mode (📖25)
- When **AF area mode** (🔑69) in **P**, **S**, **A**, or **M** mode (📖31) is set to **Face priority**

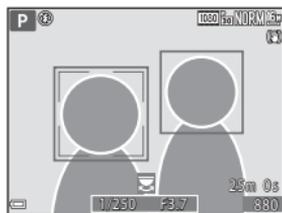

If the camera detects more than one face, a double border is displayed around the face that the camera focuses on, and single borders are displayed around the other faces.

If the shutter-release button is pressed halfway when no faces are detected:

- When **Scene auto selector** is selected, the focus area changes depending on the scene.
- In **Portrait** or **Night portrait** scene mode or smart portrait mode, the camera focuses on the area in the center of the frame.
- In  (auto) mode, **P**, **S**, **A**, or **M** mode, the camera selects the focus area containing the subject closest to the camera.

Notes About Face Detection

- The camera's ability to detect faces depends on a variety of factors, including the direction in which the faces are looking.
- The camera cannot detect faces in the following situations:
 - When faces are partially hidden by sunglasses or otherwise obstructed
 - When faces take up too much or too little of the frame

Face Detection During Movie Recording

When **AF area mode** (🔑79) in the movie menu is set to **Face priority**, the camera focuses on human faces during movie recording.

If the  () button is pressed when no faces are detected, the camera focuses on the area in the center of the frame.

Using Skin Softening

When the shutter is released while using one of the shooting modes listed below, the camera detects human faces and processes the image to soften facial skin tones (up to 3 faces).

- Smart portrait mode (📖25)
 - The skin softening level can be adjusted by the glamour retouch function.
- **Scene auto selector, Portrait, or Night portrait** scene mode (📖23)

Editing functions such as **Skin softening** can be applied to saved images by using **Glamour retouch** (📖52) even after shooting.

✔ Notes About Skin Softening

- It may take more time than usual to save images after shooting.
- Under some shooting conditions, the desired skin softening results may not be achieved, and skin softening may be applied to areas of the image where there are no faces.

Subjects Not Suitable for Autofocus

The camera may not focus as expected in the following situations. In some rare cases, the subject may not be in focus despite the fact that the focus area or the focus indicator is displayed in green:

- Subject is very dark
- Objects of sharply differing brightness are included in the scene (e.g. the sun behind the subject makes that subject appear very dark)
- No contrast between the subject and surroundings (e.g. a portrait subject wearing a white shirt is standing in front of a white wall)
- Several objects are at different distances from the camera (e.g. the subject is inside a cage)
- Subjects with repeating patterns (window blinds, buildings with multiple rows of similarly shaped windows, etc.)
- Subject is moving rapidly

In the situations noted above, try pressing the shutter-release button halfway to refocus several times, or focus on another subject positioned at the same distance from the camera as the actual desired subject, and use focus lock (📷19).

Using Target Finding AF

When **AF area mode** (69) in **P**, **S**, **A**, or **M** mode is set to **Target finding AF**, the camera focuses in the manner described below when you press the shutter-release button halfway.

- The camera detects the main subject and focuses on it. When the subject is in focus, the focus area is displayed in green. If a human face is detected, the camera automatically sets focus priority on it.

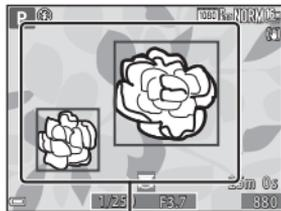

Focus areas

- If no main subject is detected, the camera automatically selects one or more of the nine focus areas containing the subject closest to the camera. When the subject is in focus, the focus areas that are in focus is displayed in green.

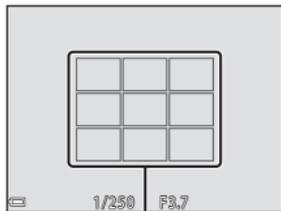

Focus areas

✓ Notes About Target Finding AF

- Depending on shooting conditions, the subject that the camera determines to be the main subject may vary.
- The main subject may not be detected when using certain **White balance** settings.
- The camera may not detect the main subject appropriately in the following situations:
 - When the subject is very dark or bright
 - When the main subject lacks clearly defined colors
 - When the shot is framed so that the main subject is at the edge of the monitor
 - When the main subject is composed of a repeating pattern

Focus Lock

Focus lock shooting is recommended when the camera does not activate the focus area that contains the desired subject.

1 In **P**, **S**, **A**, or **M** mode, set **AF area mode** to **Center** (669).

2 Position the subject in the center of the frame and press the shutter-release button halfway.

- The camera focuses on the subject and the focus area is displayed in green.
- Exposure is also locked.



3 Without lifting your finger, recompose the picture.

- Make sure to maintain the same distance between the camera and the subject.

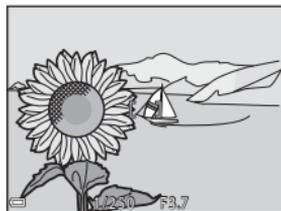

4 Press the shutter-release button the rest of the way down to take the picture.



The Control Range of the Shutter Speed (P, S, A, or M Modes)

The control range of the shutter speed differs depending on the zoom position, aperture, or the ISO sensitivity setting. Additionally, the control range changes in the following continuous shooting settings.

Setting		Control range (second)			
		P mode	S mode	A mode	M mode
ISO sensitivity ( 68)	Auto ¹	1/2000–1 s	1/2000 ² –2 s		1/2000–8 s
	ISO 125–400 ¹ , ISO 125–800 ¹		1/2000 ² –4 s		
	ISO 125, 200		1/2000 ² –8 s		
	ISO 400, 800		1/2000 ² –4 s		
	ISO 1600		1/2000 ² –2 s		
	ISO 3200, 6400		1/2000 ² –1 s		
Continuous ( 65)	Continuous H, Continuous L	1/2000 ² –1 s			
	Pre-shooting cache	1/4000–1/120 s			
	Continuous H: 120 fps				
	Continuous H: 60 fps	1/4000–1/60 s			

¹ In **M** mode, the ISO sensitivity is fixed at ISO 125.

² In **A** mode, the maximum shutter speed varies depending on the aperture value. When the aperture value is set to f/3.7 to 5.3 at the wide-angle position or f/6.4 to 8 at the telephoto zoom position, the maximum shutter speed is 1/1000 second.

Playback Zoom

Moving the zoom control toward **T** (Q playback zoom) in full-frame playback mode (📖18) zooms in on the image.

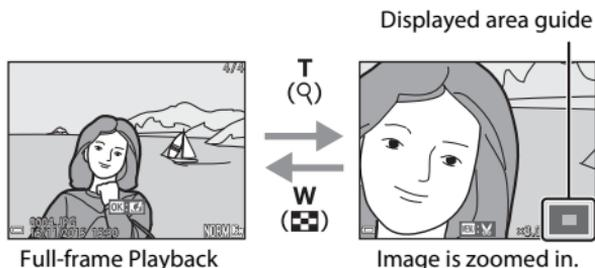

- You can change the magnification rate by moving the zoom control toward **W** (🔍) or **T** (Q). The zoom can also be adjusted by rotating the command dial.
- To view a different area of the image, press the multi selector ▲▼◀▶.
- When a zoomed image is displayed, press the **OK** button to return to full-frame playback mode.

Cropping Images

When a zoomed image is displayed, you can press the **MENU** button to crop the image to include only the visible portion and save it as a separate file (🎮31).

Thumbnail Playback/Calendar Display

Moving the zoom control toward **W** (🗪) thumbnail playback) in full-frame playback mode (📖18) displays images as thumbnails.



- You can change the number of thumbnails displayed by moving the zoom control toward **W** (🗪) or **T** (🔍).
- While using thumbnail playback mode, use the multi selector ▲▼◀▶ or rotate it to select an image, and then press the **OK** button to display that image in full-frame playback mode.
- While using calendar display mode, use ▲▼◀▶ or rotate it to select a date, and then press the **OK** button to display the images captured on that day.

✓ Notes About Calendar Display

Images captured when the camera's date is not set are treated as images captured on January 1, 2015.

List by Date Mode

Press the  button (playback mode) → MENU button → MODE menu icon →  List by date →  button

Use the multi selector ▲▼ to select a date and then press the  button to play back the images captured on the selected date.

- Functions in the playback menu ( 52) can be used for the images in the selected shooting date (except **Copy**).
- The following operations are available while the shooting date selection screen is displayed.
 - MENU button: The functions listed below are available.
 - Slide show
 - Protect*
 - * The same setting can be applied to all images captured on the selected date.
 -  button: Deletes all images captured on the selected date.

List by date	
	30/11/2015 [3]
	25/11/2015 [2]
	20/11/2015 [11]
	15/11/2015 [4]

Notes About List by Date Mode

- Up to the most recent 29 dates can be selected. If images exist for more than 29 dates, all images saved earlier than the most recent 29 dates will be combined under **Others**.
- The 9,000 most recent images can be displayed.
- Images captured when the camera's date is not set are treated as images captured on January 1, 2015.

Viewing and Deleting Images Captured Continuously (Sequence)

Viewing Images in a Sequence

Images captured continuously or with the self-collage function are saved as a sequence.

The first image of a sequence is used as the key picture to represent the sequence when displayed in full-frame playback mode or thumbnail playback mode. For the self-collage function, a collage image is used as the key picture.

To display each image in the sequence individually, press the **OK** button.

After pressing the **OK** button, the operations listed below are available.

- To display the previous or next image, rotate the multi selector or press **◀▶**.
- To display images that are not included in the sequence, press **▲** to return to the key picture display.
- To display images in a sequence as thumbnails, or to play them back in a slide show, set **Sequence display options** to **Individual pictures** in the playback menu (**086**).



✓ Sequence Display Options

Images captured continuously with cameras other than this camera cannot be displayed as a sequence.

📎 Playback Menu Options Available When Using Sequence

- When images in a sequence are displayed in full-frame playback mode, press the **MENU** button to select functions in playback menu (**052**).
- If you press the **MENU** button when a key picture is displayed, the following settings can be applied to all images in the sequence:
 - Mark for Wi-Fi upload, Protect, Copy

Deleting Images in a Sequence

When the  (delete) button is pressed for images in a sequence, the images that are deleted vary depending on how the sequences are displayed.

- When the key picture is displayed:
 - **Current image:** All images in the displayed sequence are deleted.
 - **Erase selected images:** When a key picture is selected on the erase selected images screen (53), all images in that sequence are deleted.
 - **All images:** All images on the memory card or in the internal memory are deleted.
- When images in a sequence are displayed in full-frame playback mode:
 - **Current image:** The image currently displayed is deleted.
 - **Erase selected images:** Images that are selected in the sequence are deleted.
 - **Entire sequence:** All images in the displayed sequence are deleted.

Editing Images (Still Images)

Before Editing Images

You can easily edit images on this camera. Edited copies are saved as separate files.

Edited copies are saved with the same shooting date and time as the original.

Restrictions on Image Editing

- An image can be edited up to 10 times. Additionally, still images created by movie editing can be edited up to 9 times.
- You may not be able to edit images of a certain size or with certain editing functions.

Quick Effects: Changing Hue or Mood

Images can be processed with a variety of effects.

Select **Painting**, **Photo illustration**, **Soft portrait**, **Portrait (color + B&W)**, **Fisheye**, **Cross screen** or **Miniature effect**.

- 1 Display the image to which you want to apply an effect in full-frame playback mode and press the **OK** button.



- 2 Use the multi selector  or rotate it to select the desired effect and press the **OK** button.

- Move the zoom control ( 1) toward **T** () to switch to full-frame playback or **W** () to switch to thumbnail playback.
- To exit without saving the edited image, press the **MENU** button.

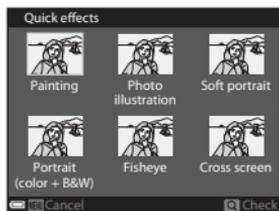

- 3 Select **Yes** and press the **OK** button.

- An edited copy is created.

Quick Retouch: Enhancing Contrast and Saturation

Press the  button (playback mode) → select an image → MENU button → Quick retouch →  button

Use the multi selector ▲▼ to select the amount of effect applied and press the  button.

- The edited version is displayed on the right.
- To exit without saving the copy, press ◀.

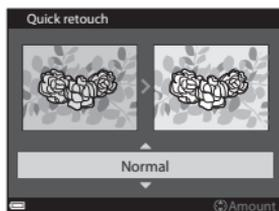

D-Lighting: Enhancing Brightness and Contrast

Press the  button (playback mode) → select an image → MENU button → D-Lighting →  button

Use the multi selector ▲▼ to select **OK** and press the  button.

- The edited version is displayed on the right.
- To exit without saving the copy, select **Cancel** and press the  button.

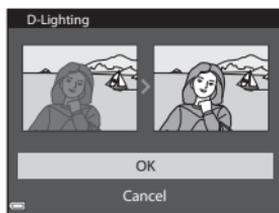

Red-eye Correction: Correcting Red-eye When Shooting with the Flash

Press the  button (playback mode) → select an image → MENU button → Red-eye correction →  button

Preview the result and press the  button.

- To exit without saving the copy, press the multi selector .

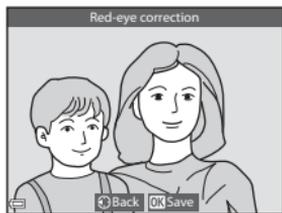

Notes About Red-eye Correction

- Red-eye correction can only be applied to images when red-eye is detected.
- Red-eye correction can be applied to pets (dogs or cats) even if their eyes are not red.
- Red-eye correction may not produce the desired results in some images.
- In rare cases, red-eye correction may be applied unnecessarily to other areas of the image.

Glamour Retouch: Enhancing Human Faces

Press the  button (playback mode) → select an image → MENU button → Glamour retouch →  button

1 Use the multi selector     to select the face that you want to retouch and press the  button.

- When only one face is detected, proceed to step 2.

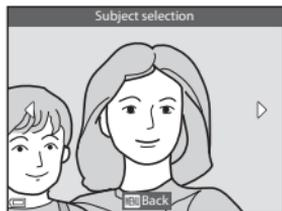

2 Use ◀▶ to select the effect, use ▲▼ to select the effect level, and press the **OK** button.

- You can simultaneously apply multiple effects.

Adjust or check the settings for all effects before pressing the **OK** button.

😊 (small face), 🗨️ (skin softening), 🗨️ (foundation makeup), 🗨️ (glare reduction), 🗨️ (hide eye bags), 🗨️ (big eyes), 🗨️ (whiten eyes), 🗨️ (eye shadow), 🗨️ (mascara), 🗨️ (whiten teeth), 🗨️ (lipstick), 🗨️ (redden cheeks)

- Press the **MENU** button to return to the screen for selecting a face.

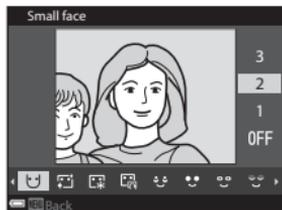

3 Preview the result and press the **OK** button.

- To change the settings, press ◀ to return to step 2.
- To exit without saving the edited image, press the **MENU** button.

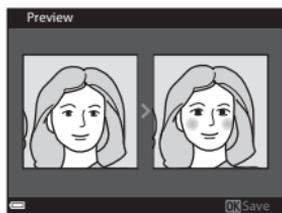

4 Select **Yes** and press the **OK** button.

- An edited copy is created.

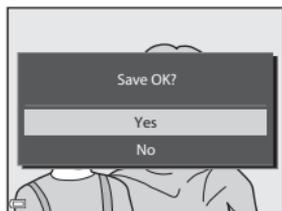

✓ **Notes About Glamour Retouch**

- One face at a time can be edited. To use the glamour retouch function for another face, edit the edited image again.
- Depending on the direction in which faces are looking, or the brightness of faces, the camera cannot accurately detect faces, or the glamour retouch function may not perform as expected.
- If no faces are detected, a warning is displayed and the screen returns to the playback menu.
- The glamour retouch function is available only for images captured at an ISO sensitivity of 1600 or lower, and the image size of 640x480 or larger.

Small Picture: Reducing the Size of an Image

Press the  button (playback mode) → select an image → MENU button → Small picture →  button

1 Use the multi selector   to select the desired copy size and press the  button.

- Images captured at an image mode setting of  **4608×2592** are saved at a size of 640 × 360, and images captured at an image mode setting of  **3456×3456** are saved at 480 × 480. Press the  button to proceed to step 2.

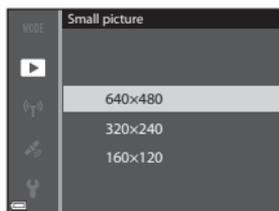

2 Select **Yes** and press the  button.

- An edited copy is created (compression ratio of approximately 1:8).

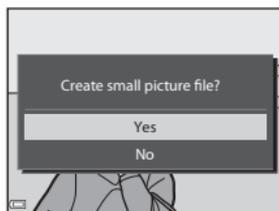

Crop: Creating a Cropped Copy

1 Move the zoom control to enlarge the image (🕶️21).

2 Adjust the image so that only the portion that you want to keep is displayed, and then press the **MENU** (menu) button.

- Move the zoom control toward **T** (🔍) or **W** (📏) to adjust the magnification rate. Set a magnification rate at which **MENU**:🕶️ is displayed.
- Use the multi selector ▲▼◀▶ to scroll to the portion of the image that you want to display.



3 Preview the image and press the **OK** button.

- To change the portion that you want to keep, press ◀ to return to step 2.
- To exit without saving the cropped image, press the ▶ button.



4 Select **Yes** and press the **OK** button.

- An edited copy is created.



Image Size

- The aspect ratio (horizontal to vertical) of a cropped image is the same as that of the original image.
- When the image size of the cropped copy is 320 × 240 or smaller, the image is displayed at a smaller size during playback.

Recording the Location Data on the Image

Press the **MENU** button →  menu icon → Location data options →  button

Set **Time zone and date** () correctly before using the location data functions.

1 Set Record location data to On.

- After the settings are complete, press the **MENU** button or shutter-release button to exit the menu.
- To receive signals easily, operate in an open-air area.

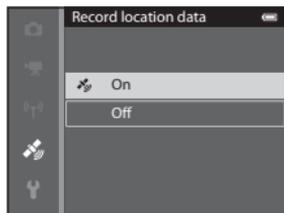

2 Check the location data reception on the shooting screen.

-  or : Signals are being received from four or more satellites, or from three satellites, and positioning is being performed. The location data is recorded on the image.
- : Signals are being received, but positioning is not possible. If the location data was obtained within the last one minute, it is recorded on the image.
- : Signals are not received. The location data is not recorded on the image.
- To display the current position on the map, press the  button while positioning is being performed ()38).



Location data reception

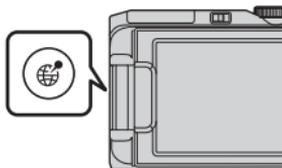

3 Shoot images while positioning is being performed.

- The location data is recorded on shot images.
- You can check the recorded location data on the map ()35).



Notes About Location Data Functions

- Before using the location data functions, read “<Important> Notes About Location Data Functions (GPS/GLONASS, Electronic Compass)” (📖xii).
- It takes a few minutes to perform positioning for the location data when positioning is performed for the first time or in a situation where positioning cannot be performed for a long period of time, or just after the battery is replaced. Using the latest A-GPS file can shorten the time needed for obtaining the location data (🔋87).
- Positions of the positioning satellites change constantly. You may not be able to determine the position or it may take some time depending on your location and the time. To use the location data functions, use the camera in an open-air area with few obstacles in the sky. Signal receiving will be smoother if the positioning antenna (📖1) is facing the sky.
- The following locations which block or reflect signals may result in failed or inaccurate positioning.
 - Inside buildings or underground locations
 - Between high-rise buildings
 - Under overpasses
 - Inside tunnels
 - Near high-voltage electrical power lines
 - Between clusters of trees
- Using a mobile phone of 1.5 GHz band near this camera may disrupt positioning.
- When carrying this camera around while positioning, do not place it in a metal bag. Positioning cannot be performed if the camera is covered with metal materials.
- When there is a significant difference in the signals from the positioning satellites, there could be a deviation of up to several hundred meters.
- Be aware of your surroundings when positioning.
- The shooting date and time that is displayed when playing back images is determined by the camera’s internal clock at the time of shooting. The time when positioning for the location data was performed can be recorded on the images, but it cannot be displayed on the camera.
- The location data for the first frame will be recorded on a series of images shot using continuous shooting.

Battery Drain While Recording Location Data and Log Recording

- When **Record location data** is set to **On**, record location data functions will continue to operate at the specified interval for approximately 6 hours even after the camera is turned off. Also, record location data functions and log recording function will continue to operate during log recording (🔋39) even after the camera is turned off.
- When **Record location data** is set to **On** or during log recording, the battery power will drain faster than usual.

Points of Interest (POI) Information

POI information is location name information for landmarks (facilities) and other details.

- When **Display POI** in **Points of interest (POI)** () of the Location data options menu is set to **On**, the nearest location name information for the current position is displayed during shooting (only when positioning is performed).
- When **Embed POI** is set to **On**, location name information can be recorded on the image during shooting (only when positioning is performed).
- If the location name information was recorded on the image during shooting, this information is displayed when **Display POI** is set to **On** during playback.
- The location name information may not be displayed depending on the setting level in **Level of detail** of **Points of interest (POI)**. Also, certain landmark names may not be registered, or the landmark name may be different.

Location name information (POI information)



Images with Recorded Location Data

- The  icon is displayed during playback for images which have the location data recorded ()5).
- The location data recorded on an image can be checked on a map with ViewNX 2 after transferring the image to a computer ()58).
- The actual place of shooting may differ from the location data recorded on the image files due to the accuracy of the location data obtained and a difference in the geodetic system used.
- The location data and POI information recorded on images can be erased using **Erase location data** in **Location data options** ()87). The erased information cannot be recovered.

Displaying the Shooting Location on the Map (While in Playback Mode)

Press the  button (playback mode) → Select images with the recorded location data* →  button

* The  icon is displayed during playback for images which have the location data recorded (5).

- Shooting location: Display the shooting location of images that have the location data recorded on the map. The shooting location of the image selected before pressing the  button is highlighted in yellow.

For the image captured with **Compass display** set to **On** (91), a rough direction of shooting is indicated by .

 (pointing to the top of the screen) indicates north.

- Thumbnail playback: Display images as thumbnails whose shooting location is on the map.
- The operations listed below can be performed during the map display.

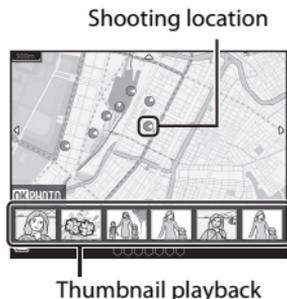

Operations of the Map

Operation	Description
Multi selector	Move the map display (in four directions).
Zoom control	T (): Zoom in the map display. W (): Zoom out the map display.
 button	Return to the playback screen.
 button*	Select images in the thumbnail playback. See "Operations When Selecting a Thumbnail Image" ( 36).

* If there is no shooting location on the displayed map, the  button is disabled.

Operations When Selecting a Thumbnail Image

Operation	Description	
Multi selector	Use ◀▶ to move the thumbnail image selection. <ul style="list-style-type: none"> The shooting location of the selected image is displayed in yellow on the map. 	
Zoom control	<ul style="list-style-type: none"> T (🔍): Display the selected image in full-frame playback mode. To display the previous or next image, press ◀▶. W (🗺️): Return to the map display. 	
🌐 button	Return to the playback screen.	
Ⓞ button	Display the menu to select the following functions.	
	Scroll map	Return to the screen for operating the map, and display the shooting location of the selected image at the center of the map.
	Save location	Save the shooting location of the selected image.
	Center on saved location	Move the map display directly to the saved location. <ul style="list-style-type: none"> See "Operations of the Map with Saved Locations" (📖37).

✔ Map Display

- Maps cannot be displayed while the camera is being charged with the Charging AC Adapter.
- The map display cannot be rotated. Only the north up display (the top of the screen indicates the north) is available.
- The map scale varies depending on which country is shown on the map.
- During the map display, you cannot select **Time zone and date**, **Format memory/Format card**, **Language**, and **Reset all** in the setup menu (📖54).

Operations of the Map with Saved Locations

When you press the  button and select **Center on saved location** while the map is displayed (, ) or thumbnails are selected (), the map scrolls to the closest saved location from the center of the screen.



- Use the multi selector  to move to other saved locations.
- Press the  button to cancel a location.
 - **Current location:** Cancel the selected saving location.
 - **Selected locations:** Cancel multiple saving locations at a time. Use the multi selector to move to other saved locations, and press the  button to select. When you press the  button again, the selection is canceled. Press the  button after selecting.
 - **All locations:** Cancel all saving locations at a time.
- Press the  button to exit the operating screen.

Displaying the Current Position on the Map (While in Shooting Mode)

Display the shooting screen while positioning is being performed¹ →
 button²

¹ See “Recording the Location Data on the Image” (📷32).

² If you press the  button when positioning is not being performed, a world map is displayed.

- The current position is displayed at the center of the map. You can save the location and display it on the map.
- When the camera lens faces downward, a compass is displayed.
- From the second time on, the previously displayed map appears after the camera is turned on.
- The operations listed below can be performed during the map display.

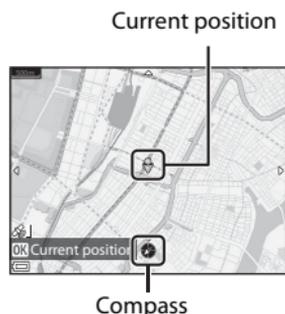

Operation	Description						
Multi selector	Move the map display (in four directions).						
Zoom control	T (📏): Zoom in the map display. W (📏): Zoom out the map display.						
 button	Return to the shooting screen.						
 button	Display the menu to select the following functions.						
	<table border="1"> <tr> <td>Center on current location*</td> <td>Display the current position at the center of the map.</td> </tr> <tr> <td>Save location</td> <td>Select a location using the multi selector and save it by pressing the  button (up to 30 locations). <ul style="list-style-type: none"> • Select No in the confirmation dialog to exit the saving location screen. </td> </tr> <tr> <td>Center on saved location</td> <td>Move the map display directly to the saved location. <ul style="list-style-type: none"> • See “Operations of the Map with Saved Locations” (📷37). </td> </tr> </table>	Center on current location*	Display the current position at the center of the map.	Save location	Select a location using the multi selector and save it by pressing the  button (up to 30 locations). <ul style="list-style-type: none"> • Select No in the confirmation dialog to exit the saving location screen. 	Center on saved location	Move the map display directly to the saved location. <ul style="list-style-type: none"> • See “Operations of the Map with Saved Locations” (📷37).
	Center on current location*	Display the current position at the center of the map.					
Save location	Select a location using the multi selector and save it by pressing the  button (up to 30 locations). <ul style="list-style-type: none"> • Select No in the confirmation dialog to exit the saving location screen. 						
Center on saved location	Move the map display directly to the saved location. <ul style="list-style-type: none"> • See “Operations of the Map with Saved Locations” (📷37). 						

* When positioning is not performed, you cannot select this function.

Recording the Log of Movement Information

Press the MENU button →  menu icon → Create log →  button

- 1 Use the multi selector ▲▼ to select **Log interval**, and press the  button.

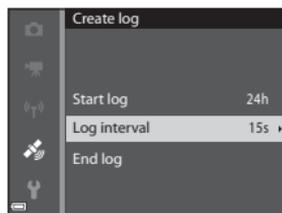

- 2 Select the intervals of log recording and press the  button.

- The default setting is **15 s**.

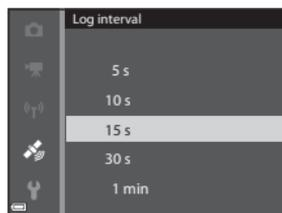

- 3 Select **Start log**, and press the  button.

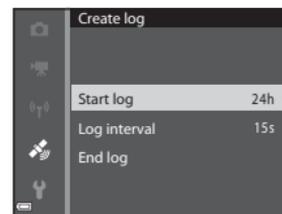

- 4 Select the duration that the log will be recorded, and press the  button.

- Log recording starts. Press the MENU button to exit the menu.
- **LOG** is displayed on the shooting screen during log recording (4).
- Log recording ends automatically after the preset time elapses, and the log data is temporarily stored in the camera. When log recording is completed, save the log data to a memory card (41).
- The log data saved on the memory card can be displayed on the map (42).

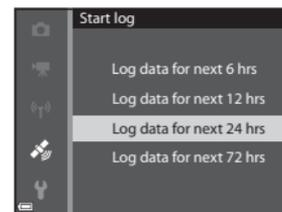

Notes About Log Recording

- If the date and time are not set, the log cannot be recorded.
- Use a fully charged battery to prevent the camera from turning off during log recording. When the battery power becomes exhausted, log recording ends.
- Even when the camera is turned off, log recording is continuously performed until the preset time has elapsed if there is still time remaining for log recording.
- Log recording ends due to the operations below even when there is time remaining for log recording.
 - The battery is removed
 - **Record location data** in **Location data options** is set to **Off**
 - **Reset all** in the setup menu is performed
 - The setting of the internal clock (time zone or date and time) is changed
 - **End log** is selected in **Create log** (0039) of the Location data options menu
- Log recording is paused during the operations below.
 - During continuous shooting
 - During movie recording
 - When connected with a USB cable or HDMI cable

Log recording is resumed when the above operations are finished.

- The log data cannot be recorded when positioning cannot be performed at all during log recording.
- The log data is temporarily stored in the camera. New logs cannot be recorded if the log data remains in the camera. After recording log data, save it to a memory card (0041).
- See “Log Data Saved on Memory Cards” (00111) for more information.

Ending Log Recording to Save it on Memory Cards

To display the obtained log data on the map, you need to save it to a memory card.

Press the MENU button →  menu icon → Create log →  button

- 1 When log recording is completed, select **End log** on the screen, and press the  button.

- Ending log can also be performed before the preset time elapses.

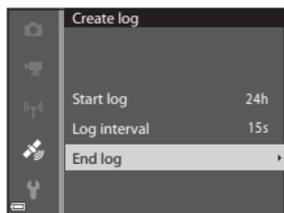

- 2 Select **Save log**, and press the  button.

- The log data is saved to a memory card.

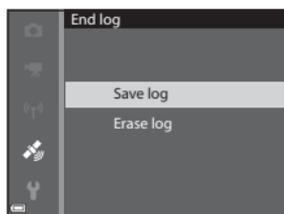

To Erase Log Data

- To erase the log data that is temporarily stored in the camera, select **Erase log** in step 2.
- To erase the log data that is stored on the memory card, press the  button in **View log**.

Viewing the Log of Location Data on the Map

Press the **MENU** button →  menu icon → View log →  button

- Select the log data (date) to be displayed, and press the  button. Your movement route based on the recorded log is displayed on the map.
- To erase the selected log or all saved logs, press the  button on the log list screen.
- The operations listed below can be performed during the map display.



Location log

Operation	Description	
Multi selector	Move the map display (in four directions).	
Zoom control	T (): Zoom in the map display. W (): Zoom out the map display.	
 button	Erase the displayed log data.	
 button	Display the menu to select the following functions.	
	Location logs	Return to the log list screen.
	Save location	Select a location using the multi selector and save it by pressing the  button (up to 30 locations). <ul style="list-style-type: none"> • Select No in the confirmation dialog to exit the saving location screen.
	Center on saved location	Move the map display directly to the saved location. <ul style="list-style-type: none"> • See "Operations of the Map with Saved Locations" (37).

Location Information Log Data

Log data is NMEA format-compliant. However, display in all NMEA format-compliant software or on all NMEA format-compliant cameras is not guaranteed.

Recording and Playing Back Movies

1 Display the shooting screen.

- Check the remaining amount of movie recording time.



Remaining movie recording time

2 Press the movie-record button to start movie recording.

- The focus area for autofocus differs depending on the setting of **AF area mode** (79).

The default setting is **Face priority**.

- Press the multi selector  to pause recording, and press  again to resume recording (except when an HS movie option is selected in **Movie options**). Recording automatically ends if it remains paused for about five minutes.

- You can capture a still image by pressing the shutter-release button while recording a movie (46).



3 Press the button again to end recording.

4 Select a movie in full-frame playback mode and press the button to play it back.

- An image with a movie options icon is a movie.



Movie options

Area Captured in Movies

- The area that is captured in a movie varies depending on the **Movie options** or **Movie VR** settings in the movie menu.
- If **Photo info** in **Monitor settings** (📷97) in the setup menu is set to **Movie frame+auto info**, you can confirm the area that will be captured in a movie before you start recording.

Maximum Movie Recording Time

Individual movie files cannot exceed 4 GB in size or 29 minutes in length, even when there is sufficient free space on the memory card for longer recording.

- The remaining recording time for a single movie is displayed on the shooting screen.
- Recording may end before either limit is reached if camera temperature becomes elevated.
- The actual remaining recording time may vary depending on the movie content, subject movement, or type of memory card.
- Memory cards with an SD Speed Class rating of 6 or faster are recommended when recording movies (📷19). Movie recording may stop unexpectedly when memory cards with a lower Speed Class rating are used.
- When using the camera's internal memory, saving movies may take some time.
- Depending on the file size of a movie, it may not be possible to save the movie in the internal memory or copy it from a memory card to the internal memory.

Notes About Camera Temperature

- The camera may become hot when shooting movies for an extended period of time or when the camera is used in a hot area.
- If the inside of the camera becomes extremely hot when recording movies, the camera will automatically stop recording. The amount of time remaining until the camera stops recording (🔥10s) is displayed. After the camera stops recording, it turns itself off. Leave the camera off until the inside of the camera has cooled.

Notes About Movie Recording

✓ Notes About Saving Images or Movies

The indicator showing the number of exposures remaining or the indicator showing the remaining recording time flashes while images or movies are being saved. **Do not open the battery-chamber/memory card slot cover or remove the battery or memory card** while an indicator is flashing. Doing this could result in loss of data, or in damage to the camera or the memory card.

✓ Notes About Recorded Movies

- There may be some degradation in image quality when digital zoom is used.
- The sounds of zoom control operation, zoom, autofocus lens drive movement, vibration reduction, and aperture operation when brightness changes may be recorded.
- The following phenomena may be seen in the monitor while recording movies. These phenomena are saved in the recorded movies.
 - Banding may occur in images under fluorescent, mercury-vapor, or sodium-vapor lighting.
 - Subjects that move quickly from one side of the frame to the other, such as a moving train or car, may appear skewed.
 - The entire movie image may be skewed when the camera is panned.
 - Lighting or other bright areas may leave residual images when the camera is moved.
- Depending on the distance to the subject or the amount of zoom applied, colored stripes may appear on subjects with repeating patterns (fabrics, lattice windows, etc.) during movie recording and playback. This occurs when the pattern in the subject and the layout of the image sensor interfere with each other; it is not a malfunction.

✓ Notes About Vibration Reduction During Movie Recording

- When **Movie VR** (81) in the movie menu is set to **On (hybrid)**, the angle of view (i.e., the area visible in the frame) becomes narrower during movie recording.
- When using a tripod to stabilize the camera during recording, set **Movie VR** to **Off** to prevent potential errors caused by this function.

✓ Notes About Autofocus for Movie Recording

Autofocus may not perform as expected (17). Should this occur, try the following:

1. Set **AF area mode** to **Center** and **Autofocus mode** to **Single AF** (default setting) in the movie menu before starting movie recording.
2. Frame another subject—positioned at the same distance from the camera as the intended subject—in the center of the frame, press the **●** (AF-ON) button to start recording, and then modify the composition.

Capturing Still Images While Recording Movies

If the shutter-release button is pressed all the way while recording a movie, one frame is saved as a still image. Movie recording continues while the still image is being saved.

- While  is displayed in the monitor, still images can be captured. While  is displayed, still images cannot be captured.
- The size of the captured image varies depending on the **Movie options** setting (75).



Notes About Capturing Still Images During Movie Recording

- Still images cannot be saved during movie recording in the following situations:
 - When movie recording is paused
 - When the remaining movie recording time is less than five seconds
 - When **Movie options** is set to  **1080/60i**,  **1080/50i**,  **480/30p**,  **480/25p**, or HS movie
- The frames of a movie that were recorded when a still image was being captured may not play back smoothly.
- The sounds of operating the shutter-release button when saving a still image may be heard in the recorded movie.
- If the camera moves when the shutter-release button is pressed, the image may be blurred.

Operations During Movie Playback

To adjust the volume, move the zoom control while a movie is playing (📖1).

Rotate the multi selector or the command dial to fast forward or rewind.

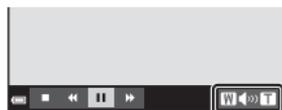

Volume indicator

Playback controls are displayed in the monitor.

The operations described below can be performed by using the multi selector ◀▶ to select a control and then pressing the OK button.



When paused

Function	Icon	Description	
Rewind	◀	Hold down the OK button to rewind the movie.	
Advance	▶	Hold down the OK button to advance the movie.	
Pause	⏸	Pause playback. The operations listed below can be performed while paused.	
		◀⏸	Rewind the movie one frame. Hold down the OK button for continuous rewinding.*
		▶⏸	Advance the movie one frame. Hold down the OK button for continuous advancing.*
		▶	Resume playback.
		📄	Extract the desired portion of a movie and save it as a separate file.
	📄	Extract a single frame of a movie and save it as a still image.	
End	■	Return to full-frame playback mode.	

* The movie can also be advanced or rewound by rotating the multi selector or command dial.

Editing Movies

When editing movies, use a sufficiently charged battery to prevent the camera from turning off during editing. When the battery level indicator is , movie editing is not possible.

Extracting Only the Desired Portion of a Movie

The desired portion of a recorded movie can be saved as a separate file.

1 Play back a desired movie and pause at the start point of the portion that you want to extract (47).

2 Use the multi selector  to select  in the playback controls, and then press the  button.

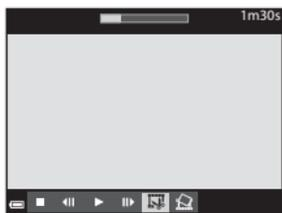

3 Use  to select  (choose start point) in the editing controls.

- Use  or rotate it to move the start point.
- To cancel editing, select  (back), and press the  button.



4 Use  to select  (choose end point).

- Use  or rotate it to move the end point.
- To preview the specified portion, select  and then press the  button. Press the  button again to stop previewing.



5 Use ▲▼ to select [] (save) and press the OK button.

- Follow the instructions on the screen to save the movie.

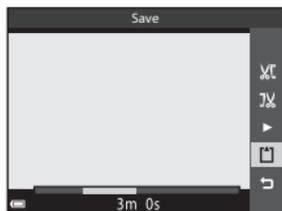

✓ Notes About Movie Editing

- A movie that was created by editing cannot be trimmed again.
- The actual trimmed portion of a movie may differ slightly from the portion selected using the start and end points.
- Movies cannot be trimmed so that they are less than two seconds long.

Saving a Frame from a Movie as a Still Image

The desired frame of a recorded movie can be extracted and saved as a still image.

- Pause a movie and display the frame to be extracted (🎮47).
- Use the multi selector ◀▶ to select the [] button.

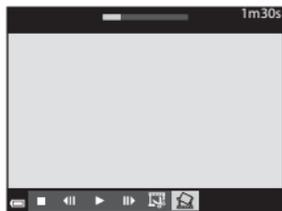

- Select **Yes** when a confirmation dialog is displayed, and press the OK button to save the image.
- The image quality of the saved still image is **Normal**. The image size is determined by the type (image size) (🎮75) of the original movie. For example, a still image saved from a movie recorded with $\frac{1080}{60}$ **1080/30p** or $\frac{1080}{25}$ **1080/25p** is $\frac{1080}{24}$ (1920 × 1080 pixels).

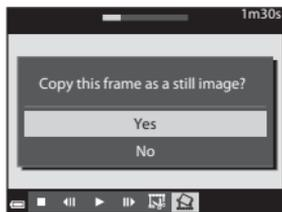

✓ Notes About Saving Still Images

Frames of movies recorded with $\frac{1080}{60}$ **1080/60i**, $\frac{1080}{50}$ **1080/50i**, $\frac{480}{60}$ **480/30p**, $\frac{480}{25}$ **480/25p**, and HS movies (🎮75) cannot be saved as still images.

Connecting to a Smart Device (Wi-Fi)

- 1 Press the ((T)) (Wi-Fi) button on the camera.

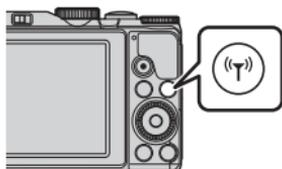

- The screen shown on the right is displayed.
- If no connection confirmation is received from the smart device within 3 minutes, the message **No access.** is displayed and the camera returns to the Wi-Fi options screen.
- You can also select **Connect to smart device** in the Wi-Fi options menu to display the screen shown on the right.

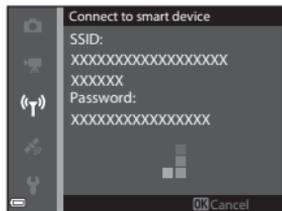

- 2 Set the Wi-Fi setting on the smart device to On.

- Check the user's manual provided with your smart device for further details.
- After the network names (SSIDs) that can be used for the smart device are displayed, select the SSID displayed on the camera.
- When **Auth./encryp.** is set to **WPA2-PSK-AES** in the Wi-Fi options menu, the message for entering a password is displayed. Enter the password that is displayed on the camera.

- 3 Start the "Wireless Mobile Utility" installed on the smart device, while **Negotiating... Please wait.** is displayed on the camera.

- The screen for selecting "Take photos" or "View photos" is displayed.
- When the message "Cannot connect to camera." is displayed, return to step 1 and retry the procedure.
- See "Installing the Software on the Smart Device" (📖56).

Touching an NFC-compatible Smart Device to the Camera for a Wi-Fi Connection

When you use a smart device that is compatible with near field communication (NFC) functions and runs on Android OS, you can establish a Wi-Fi connection and start the “Wireless Mobile Utility” by touching the NFC antenna on the smart device to the  (N-Mark) on the camera.

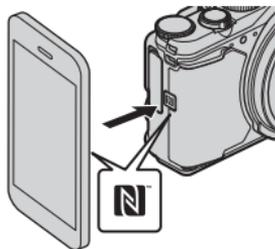

To Terminate the Wi-Fi Connection

Perform one of the operations described below.

- Turn off the camera.
- Select **Disable Wi-Fi** in the Wi-Fi options menu on the camera (except when the camera is operated by remote control).
- Set the Wi-Fi setting on the smart device to Off.

Notes About Wi-Fi Connection

- Wi-Fi connection operations are disabled in the following situations:
 - When the camera is connected to a TV, printer, or computer
 - While recording movies
 - While the camera is processing data such as saving images or recording movies
 - When the camera is connected to a smart device
- Select **Disable Wi-Fi** in areas where the use of radio waves is prohibited.
- When Wi-Fi is connected, **Auto off** is disabled.
- When Wi-Fi is connected, the battery drains faster than normal.
- The Wi-Fi connection is terminated in the following situations:
 - When the battery level is low
 - When starting movie recording in short movie show mode

Security Settings

If no security settings (encryption and password) are configured for the camera's Wi-Fi function, unauthorized third parties may access the network and cause harm. We strongly recommend performing the required security settings before using the Wi-Fi function.

Use **Options** in the Wi-Fi options menu (93) to perform the security settings.

Preselecting Images in the Camera That You Want to Transfer to a Smart Device

You can preselect images in the camera that you want to transfer to a smart device. Movies cannot be preselected for transfer.

1 Select images to transfer.

You can preselect the images to transfer to a smart device in the following menus:

- **Mark for Wi-Fi upload** in the playback menu (📷82)
- **Upload from camera** in the Wi-Fi options menu (📷93)

When using **Upload from camera**, the SSID and password of the camera are displayed after images are selected.

2 Connect the camera and smart device (📷50).

- Tapping “View photos” in the “Wireless Mobile Utility” displays the confirmation screen to transfer the specified images to the smart device.

Preselecting Images to Transfer During Playback

While the camera is in playback mode, press the (⏮) button or use the NFC function to establish a Wi-Fi connection, and preselect the displayed images that you want to transfer.

- You can preselect one image in full-frame playback mode. You can preselect all images in the sequence when the key picture is displayed for images in a sequence.
- You can preselect one image specified in thumbnail playback mode. You can preselect all images in the sequence when the key picture is displayed for images in a sequence.
- You can preselect all the images captured on the selected date in calendar display playback mode.

This operation is not available when you use **Connect to smart device** in the Wi-Fi options menu to establish the Wi-Fi connection.

Connecting the Camera to a TV (Playback on a TV)

1 Turn off the camera and connect it to the TV.

- Make sure that the plugs are properly oriented. Do not insert or remove the plugs at an angle when connecting or disconnecting them.

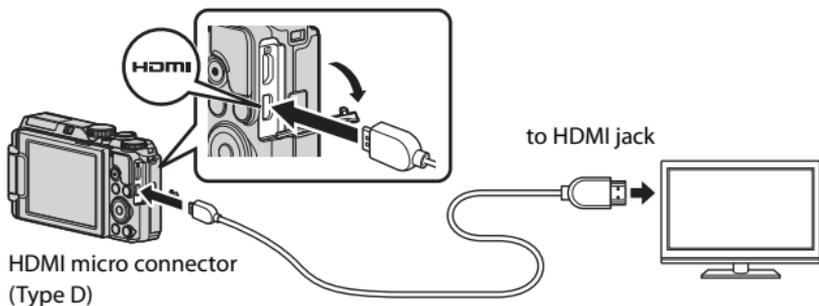

2 Set the TV's input to external input.

- See the documentation provided with your TV for details.

3 Hold down the (playback) button to turn on the camera.

- Images are displayed on the TV.
- The camera monitor does not turn on.

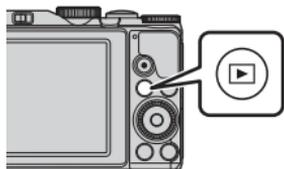

Connecting the Camera to a Printer (Direct Print)

Users of PictBridge-compatible printers can connect the camera directly to the printer and print images without using a computer.

Connecting the Camera to a Printer

- 1 Turn on the printer.
- 2 Turn off the camera and connect it to the printer using the USB cable.
 - Make sure that the plugs are properly oriented. Do not insert or remove the plugs at an angle when connecting or disconnecting them.

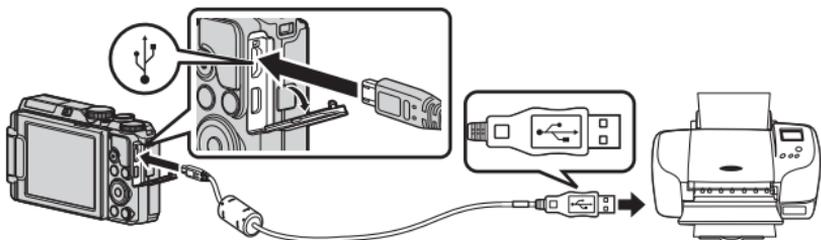

- 3 The camera is automatically turned on.
 - The **PictBridge** startup screen (①) is displayed in the camera monitor, followed by the **Print selection** screen (②).

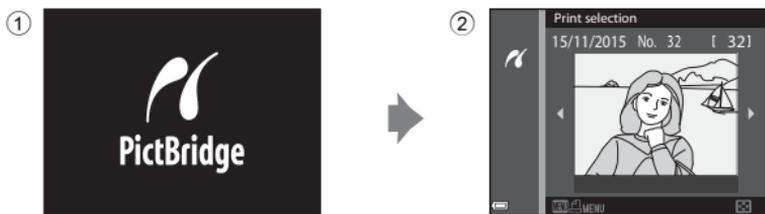

❑ If the PictBridge Startup Screen Is Not Displayed

When **Auto** is selected for **Charge by computer** (📷104), it may be impossible to print images with direct connection of the camera to some printers. If the PictBridge startup screen is not displayed after the camera is turned on, turn the camera off and disconnect the USB cable. Set **Charge by computer** to **Off** and reconnect the camera to the printer.

Printing Images One at a Time

- 1 Use the multi selector ◀▶ to select the desired image and press the **OK** button.

- Move the zoom control toward **W** (📐) to switch to thumbnail playback or **T** (🔍) to switch to full-frame playback.



- 2 Use ▲▼ to select **Copies** and press the **OK** button.

- Use ▲▼ to set the desired number of copies (up to 9) and press the **OK** button.

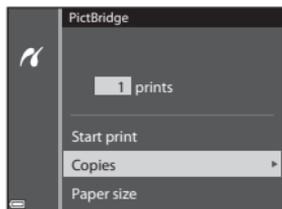

- 3 Select **Paper size** and press the **OK** button.

- Select the desired paper size and press the **OK** button.
- To print with the paper size setting configured on the printer, select **Default**.
- The paper size options available on the camera vary depending on the printer that you use.

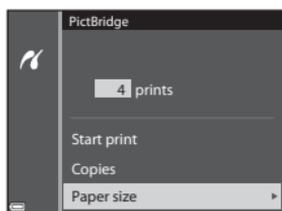

- 4 Select **Start print** and press the **OK** button.

- Printing starts.

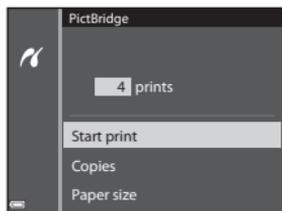

Printing Multiple Images

- 1 When the **Print selection** screen is displayed, press the **MENU** (menu) button.



- 2 Use the multi selector ▲▼ to select **Paper size** and press the **OK** button.

- Select the desired paper size and press the **OK** button.
- To print with the paper size setting configured on the printer, select **Default**.
- The paper size options available on the camera vary depending on the printer that you use.
- To exit the print menu, press the **MENU** button.

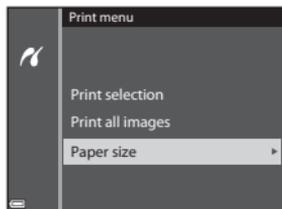

- 3 Select **Print selection**, or **Print all images** and press the **OK** button.

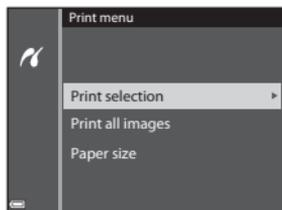

Print selection

Select images (up to 99) and the number of copies (up to 9) of each.

- Use the multi selector ◀▶ to select images, and use ▲▼ to specify the number of copies to be printed.
- Images selected for printing are indicated by 🖨️ and the number of copies to be printed. To cancel the print selection, set the number of copies to 0.
- Move the zoom control toward **T** (🔍) to switch to full-frame playback or **W** (🖼️) to switch to thumbnail playback.
- Press the **OK** button when setting is complete. When the screen for confirming the number of print copies is displayed, select **Start print** and press the **OK** button to start printing.



Print all images

One copy each of all images saved in the internal memory, or on the memory card, is printed.

- When the screen for confirming the number of print copies is displayed, select **Start print** and press the **OK** button to start printing.

Using ViewNX 2 (Transferring Images to a Computer)

Installing ViewNX 2

ViewNX 2 is free software that enables you to transfer images and movies to your computer so that you can view, edit, or share them. To install ViewNX 2, download the ViewNX 2 installer from the website below and follow the onscreen installation instructions.

<http://nikonimglib.com/nvnx/>

For system requirements and other information, see the Nikon website for your region.

Transferring Images to a Computer

1 Prepare a memory card that contains images.

You can use any of the methods below to transfer images from the memory card to a computer.

- **SD memory card slot/card reader:** Insert the memory card into the card slot of your computer or the card reader (commercially available) that is connected to the computer.
- **Direct USB connection:** Turn the camera off and ensure that the memory card is inserted in the camera. Connect the camera to the computer using the USB cable.

The camera automatically turns on.

To transfer images that are saved in the camera's internal memory, remove the memory card from the camera before connecting it to the computer.

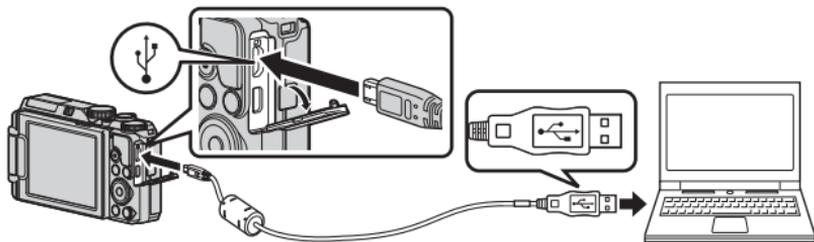

If a message is displayed prompting you to choose a program, select Nikon Transfer 2.

- **When using Windows 7**

If the dialog shown at right is displayed, follow the steps below to select Nikon Transfer 2.

- 1 Under **Import pictures and videos**, click **Change program**. A program selection dialog will be displayed; select **Import File using Nikon Transfer 2** and click **OK**.
- 2 Double-click **Import File**.



If the memory card contains a large number of images, it may take a while for Nikon Transfer 2 to start. Wait until Nikon Transfer 2 starts.

✓ **Notes About Connecting the USB Cable**

Operation is not guaranteed if the camera is connected to the computer via a USB hub.

2 After Nikon Transfer 2 starts, click **Start Transfer**.

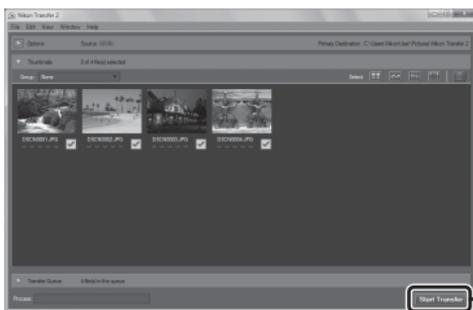

- Image transfer begins. When image transfer is complete, ViewNX 2 starts and the transferred images are displayed.
- Consult online help for more information on using ViewNX 2.

3 Terminate the connection.

- If you are using a card reader or card slot, choose the appropriate option in the computer operating system to eject the removable disk corresponding to the memory card and then remove the memory card from the card reader or card slot.
- If the camera is connected to the computer, turn the camera off and disconnect the USB cable.

The Shooting Menu (The Common Shooting Options)

Image Quality

Enter shooting mode* → MENU button → Image quality →  button

* The image quality can be set in shooting modes other than the short movie show mode. The setting is also applied to other shooting modes (except **Time-lapse movie** and **Easy panorama** scene modes).

Set the image quality (compression ratio) used when saving images.

Lower compression ratios result in higher quality images, but the number of images that can be saved is reduced.

Option	Description
FINE Fine	Finer image quality than Normal . Compression ratio: Approx. 1:4
NORM Normal (default setting)	Normal image quality, suitable for most applications. Compression ratio: Approx. 1:8

Notes About Image Quality

This function may not be available to use in combination with other functions (44).

Number of Images That Can Be Saved

- The approximate number of images that can be saved can be checked in the monitor when shooting (3).
- Note that due to JPEG compression, the number of images that can be saved may vary greatly depending on the image content, even when using memory cards with the same capacity and the same image quality and image size settings. In addition, the number of images that can be saved may vary depending on the make of the memory card.
- If the number of exposures remaining is 10,000 or more, the number of exposures remaining display shows "9999".

Image Size

Enter shooting mode* → MENU button → Image size →  button

* The image size can be set in shooting modes other than the short movie show mode. The setting is also applied to other shooting modes (except **Time-lapse movie** and **Easy panorama** scene modes).

Set the image size (number of pixels) used when saving images.

The larger the image size, the larger the size at which it can be printed, but the number of images that can be saved is reduced.

Option*	Aspect ratio (horizontal to vertical)
 4608×3456 (default setting)	4:3
 3264×2448	4:3
 2272×1704	4:3
 1600×1200	4:3
 640×480	4:3
 4608×2592	16:9
 3456×3456	1:1

* The numerical values indicate the number of pixels that are captured.
Example:  **4608×3456** = approx. 16 megapixels, 4608 × 3456 pixels

Notes About Printing Images at 1:1 Aspect Ratio

Change the printer setting to “Border” when printing images at a 1:1 aspect ratio. Some printers may not be able to print images at a 1:1 aspect ratio.

Notes About Image Size

This function may not be available to use in combination with other functions ( 44).

The Shooting Menu (P, S, A, or M Mode)

- See “Image Quality” (📷60) and “Image Size” (📷61) for information about **Image quality** and **Image size**.

White Balance (Adjusting Hue)

Rotate the mode dial to P, S, A or M → MENU button → P, S, A, or M menu icon → White balance →  button

Adjust white balance to suit the light source or weather conditions in order to make the colors in images match what you see with your eyes.

Option	Description
AUTO Auto (default setting)	White balance is automatically adjusted.
PRE Preset manual	Use when the desired result is not achieved with Auto , Incandescent , etc. (📷63).
 Daylight	Use under direct sunlight.
 Incandescent	Use under incandescent lighting.
 Fluorescent	Use under fluorescent lighting.
 Cloudy	Use under overcast skies.
 Flash	Use with the flash.

Notes About White Balance

- Lower the flash when white balance is set to any setting other than **Auto** and **Flash** (📖16).
- This function may not be available to use in combination with other functions (📖44).

Using Preset Manual

Use the procedure below to measure the white balance value under the lighting used during shooting.

1 Place a white or gray reference object under the lighting that will be used during shooting.

2 Use the multi selector ▲▼ to select **Preset manual** in the **White balance** menu, and press the **OK** button.

- The camera zooms in to the position for measuring white balance.

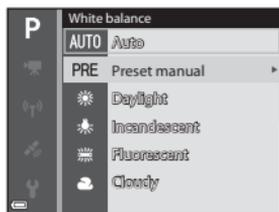

3 Select **Measure**.

- To apply the last measured value, select **Cancel** and press the **OK** button.

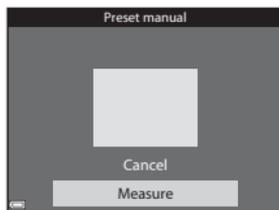

4 Frame the white or gray reference object in the measuring window, and press the **OK** button to measure the value.

- The shutter is released and measurement is complete (no image is saved).

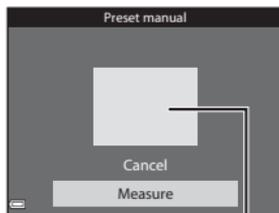

Measuring window

✓ Notes About Preset Manual

A value for flash lighting cannot be measured with **Preset manual**. When shooting using the flash, set **White balance** to **Auto** or **Flash**.

Metering

Rotate the mode dial to **P, S, A** or **M** → **MENU** button → **P, S, A,** or **M** menu icon → **Metering** →  button

The process of measuring the brightness of the subject to determine the exposure is known as “metering.”

Use this option to set the method of how the camera meters exposure.

Option	Description
 Matrix (default setting)	The camera uses a wide area of the screen for metering. Recommended for typical shooting.
 Center-weighted	The camera meters the entire frame but assigns greatest weight to the subject in the center of the frame. The classic metering for portraits; it preserves background details while letting lighting conditions in the center of the frame determine exposure. Can be used with focus lock ( 19) to meter off-center subjects.

Notes About Metering

- When digital zoom is in effect, **Center-weighted** or spot metering (where the center of the frame is metered) is selected depending on the magnification of an enlargement.
- This function may not be available to use in combination with other functions ( 44).

Metering Area

When **Center-weighted** is selected for **Metering**, the metering range guide ( 3) is displayed (except when digital zoom is used).

Continuous Shooting

Rotate the mode dial to **P, S, A** or **M** → **MENU** button → **P, S, A,** or **M** menu icon → Continuous → **OK** button

Option	Description
 S Single (default setting)	One image is captured each time the shutter-release button is pressed.
 H Continuous H	While the shutter-release button is held all the way down, images are captured continuously. <ul style="list-style-type: none">• The frame rate for continuous shooting is about 7 fps and the maximum number of continuous shots is about 5 (when image quality is set to Normal and when image size is set to  4608x3456).
 L Continuous L	While the shutter-release button is held all the way down, images are captured continuously. <ul style="list-style-type: none">• The frame rate for continuous shooting is about 2.2 fps and the maximum number of continuous shots is about 11 (when image quality is set to Normal and when image size is set to  4608x3456).
 Pre-shooting cache	When the shutter-release button is pressed halfway, pre-shooting cache shooting begins. When the shutter-release button is pressed the rest of the way down, the camera saves the current image as well as the images captured immediately before the button is pressed ( 67). This function helps you to avoid missing the shot. <ul style="list-style-type: none">• The frame rate for continuous shooting is about 15 fps and the maximum number of continuous shots is 25, including a maximum of 5 frames captured in the pre-shooting cache.• The image quality is fixed at Normal and the image size is fixed at  (1280 × 960 pixels).
 120 Continuous H: 120 fps	Each time the shutter-release button is pressed all the way, images are captured at a high speed rate. <ul style="list-style-type: none">• The frame rate for continuous shooting is about 120 fps and the maximum number of continuous shots is 50.• The image quality is fixed at Normal and the image size is fixed at  640x480.

Option	Description
 60 Continuous H: 60 fps	Each time the shutter-release button is pressed all the way, images are captured at a high speed rate. <ul style="list-style-type: none"> • The frame rate for continuous shooting is about 60 fps and the maximum number of continuous shots is 25. • The image quality is fixed at Normal and the image size is fixed at  (1280 × 960 pixels).

Notes About Continuous Shooting

- Focus, exposure, and white balance are fixed at the values determined with the first image in each series.
- It may take some time to save the images after shooting.
- When ISO sensitivity increases, noise may appear in captured images.
- The frame rate for continuous shooting may become slow depending on the current image quality setting, image size setting, the memory card used, or shooting condition.
- When using **Pre-shooting cache, Continuous H: 120 fps, or Continuous H: 60 fps**, banding or variance in brightness or hue may occur in images that were captured under lighting that flickers at high speeds, such as fluorescent, mercury-vapor, or sodium-vapor lighting.
- This function may not be available to use in combination with other functions (44).

Pre-shooting Cache

When the shutter-release button is pressed halfway or all the way down, images are saved as described below.

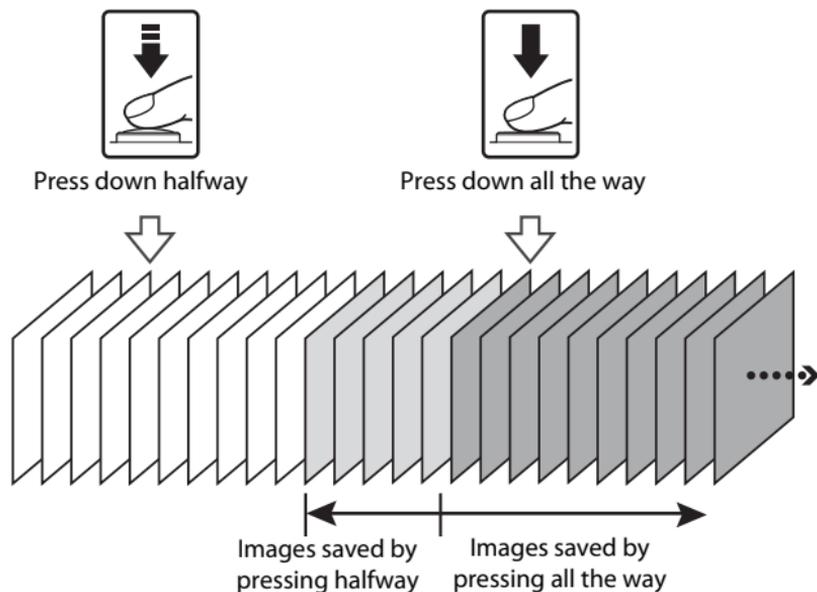

- The pre-shooting cache icon () on the shooting screen changes to green while the shutter-release button is pressed halfway.

ISO Sensitivity

Rotate the mode dial to **P, S, A** or **M** → **MENU** button → **P, S, A,** or **M** menu icon → ISO sensitivity → **OK** button

A higher ISO sensitivity allows darker subjects to be captured. Additionally, even with subjects of similar brightness, pictures can be taken at faster shutter speeds, and blurring caused by camera shake and subject movement can be reduced.

- When a higher ISO sensitivity is set, images may contain noise.

Option	Description
AUTO Auto (default setting)	Sensitivity is automatically selected from the range of ISO 125 to 1600.
ISO AUTO Fixed range auto	Select the range in which the camera automatically adjusts ISO sensitivity, from ISO 125-400 or ISO 125-800 .
125, 200, 400, 800, 1600, 3200, 6400	Sensitivity is locked at the specified value.

Notes About ISO Sensitivity

This function may not be available to use in combination with other functions (📖44).

ISO Sensitivity Display on the Shooting Screen

- When **Auto** is selected, **ISO** is displayed when the ISO sensitivity increases.
- When **Fixed range auto** is selected, the maximum value for ISO sensitivity is displayed.

AF Area Mode

Rotate the mode dial to **P**, **S**, **A** or **M** → **MENU** button → **P**, **S**, **A**, or **M** menu icon → **AF area mode** → **OK** button

Set how the camera selects the focus area for autofocus when shooting still images.

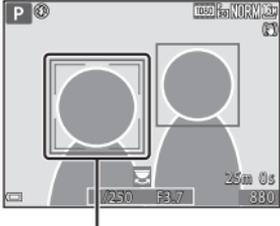
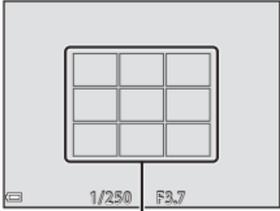
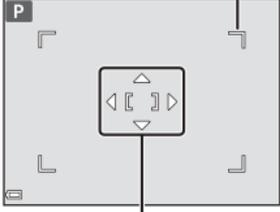
Option	Description
<p> Face priority</p>	<p>When the camera detects a human face, it focuses on that face. See “Using Face Detection” (📖 16) for more information.</p>  <p>Focus area</p> <p>When framing a composition with no human subjects or detected faces, the camera automatically selects one or more of the 9 focus areas containing the subject closest to the camera when the shutter-release button is pressed halfway.</p>  <p>Focus areas</p>
<p> Manual</p>	<p>Use the multi selector  to move the focus area to where you want to focus.</p> <ul style="list-style-type: none"> To use the multi selector to configure the flash mode or other settings, press the OK button. To return to moving the focus area, press the OK button again. <p>Scope of movable focus area</p>  <p>Focus area</p>

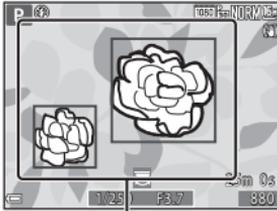
Option	Description	
<p>[▪] Center</p>	<p>The camera focuses on the subject in the center of the frame.</p>	 <p>The image shows a camera viewfinder with a central focus area bracket. The viewfinder includes various icons and data: 'P' in the top left, '100% F11 NORM' in the top right, '25m 0s' in the bottom right, and '1/250 F3.7 880' in the bottom center. A bracket is centered in the frame, with a vertical line pointing to the text 'Focus area' below it.</p>
<p> Subject tracking</p>	<p>Use this function to take pictures of moving subjects. Register the subject on which the camera focuses. The focus area automatically moves to track the subject. See "Using Subject Tracking" (71) for more information.</p>	 <p>The image shows a camera viewfinder with a subject tracking focus area. The viewfinder includes various icons and data: 'P' in the top left, '100% F11 NORM' in the top right, '25m 0s' in the bottom right, and '1/250 F3.7 880' in the bottom center. A focus area is shown in the center, with a 'OK Start' button below it. A vertical line points from the focus area to the text 'Focus area' below the image.</p>
<p> Target finding AF (default setting)</p>	<p>When the camera detects the main subject, it focuses on that subject. See "Using Target Finding AF" (18) for more information.</p>	 <p>The image shows a camera viewfinder with target finding AF focus areas. The viewfinder includes various icons and data: 'P' in the top left, '100% F11 NORM' in the top right, '25m 0s' in the bottom right, and '1/250 F3.7 880' in the bottom center. Two focus areas are shown, one larger and one smaller, both centered on a flower. A vertical line points from the larger focus area to the text 'Focus areas' below the image.</p>

Notes About AF Area Mode

- When digital zoom is in effect, the camera focuses on the area in the center of the frame regardless of the **AF area mode** setting.
- This function may not be available to use in combination with other functions (44).

AF Area Mode for Movie Recording

AF area mode for movie recording can be set with **AF area mode** (79) in the movie menu.

Using Subject Tracking

Rotate the mode dial to **P, S, A** or **M** → **MENU** button → **P, S, A,** or **M** menu icon → **AF** area mode → **OK** button →  Subject tracking → **OK** button → **MENU** button

1 Register a subject.

- Align the subject that you want to track with the border in the center of the monitor and press the **OK** button.
- When the subject is registered, a yellow border (focus area) is displayed around it and the camera begins tracking the subject.
- If the subject cannot be registered, the border is displayed in red. Change the composition and try registering the subject again.
- To cancel subject registration, press the **OK** button.
- If the camera can no longer track the registered subject, the focus area disappears. Register the subject again.



2 Press the shutter-release button fully to take the picture.

- If the shutter-release button is pressed while the focus area is not displayed, the camera focuses on the subject in the center of the frame.

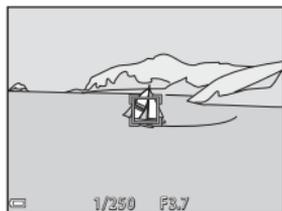

✓ Notes About Subject Tracking

- If you perform operations such as zooming while the camera is tracking the subject, the registration is canceled.
- Subject tracking may not be possible in certain shooting conditions.

Autofocus Mode

Rotate the mode dial to **P, S, A** or **M** → **MENU** button → **P, S, A,** or **M** menu icon → Autofocus mode → **OK** button

Set how the camera focuses when shooting still images.

Option	Description
AF-S Single AF	The camera focuses only when the shutter-release button is pressed halfway.
AF-F Full-time AF	The camera continues focusing even when the shutter-release button is not pressed halfway. The sound of lens drive movement is heard while the camera focuses.
PRE-AF Pre-focus (default setting)	Even when the shutter-release button is not pressed halfway, the camera focuses automatically if the composition of the framed image is significantly changed.



Autofocus Mode for Short Movie Show Mode or Movie Recording

Autofocus mode for short movie show mode or movie recording can be set with **Autofocus mode** (80) in the movie menu.

M Exposure Preview

Rotate the mode dial to **P, S, A** or **M** → **MENU** button → **P, S, A,** or **M** menu icon → M exposure preview → **OK** button

Select whether or not changes in the brightness are also reflected on the shooting screen when the exposure is changed in **M** (manual) mode.

Option	Description
On (default setting)	Changes in the brightness are reflected on the shooting screen.
Off	Changes in the brightness are not reflected on the shooting screen.

The Smart Portrait Menu

- See “Image Quality” (📷60) and “Image Size” (📷61) for information about **Image quality** and **Image size**.

Self-Collage

Rotate the mode dial to 📷 → MENU button → 📷 menu icon → Self-Collage → OK button

Option	Description
Number of shots	Set the number of shots that the camera automatically captures (number of captured images for an aggregated image). <ul style="list-style-type: none">• 4 (default setting) or 9 can be selected.
Interval	Set the interval time between each shot. <ul style="list-style-type: none">• Short, Medium (default setting), or Long can be selected.
Shutter sound	Set whether to activate the shutter sound when shooting with the self-collage function. <ul style="list-style-type: none">• Standard, SLR, Magic (default setting), or Off can be selected.• The same setting that is specified for Shutter sound in Sound settings in the setup menu is not applied to this setting.

Blink Proof

Rotate the mode dial to  → MENU button →  menu icon → Blink proof →  button

Option	Description
 On	<p>The camera automatically releases the shutter twice with every shot and saves one image in which the subject's eyes are open.</p> <ul style="list-style-type: none">• If the camera saved an image in which the subject's eyes may have been closed, the dialog shown on the right is displayed for a few seconds.
Off (default setting)	Turns the blink proof off.

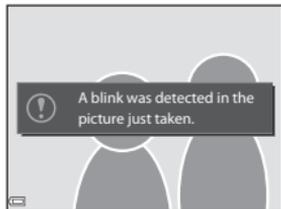

Notes About Blink Proof

This function may not be available to use in combination with other functions (44).

The Movie Menu

Movie Options

Enter shooting mode → MENU button →  menu icon → Movie options
→  button

Select the desired movie option to record. Select normal speed movie options to record at normal speed, or HS movie options () to record in slow or fast motion. The movie options that can be selected vary depending on the **Frame rate** setting (.

- Memory cards with an SD Speed Class rating of 6 or faster are recommended for recording movies (-19).

Normal Speed Movie Options

Option (Image size/Frame rate*, File format)	Image size	Aspect ratio (horizontal to vertical)
 1080/30p  1080/25p (default setting)	1920 × 1080	16:9
 1080/60i*  1080/50i*	1920 × 1080	16:9
 720/30p  720/25p	1280 × 720	16:9
 480/30p  480/25p	640 × 480	4:3

* Interlaced format uses Fields per second.

HS Movie Options

Recorded movies are played back in fast or slow motion.

See “Recording Movies in Slow Motion and Fast Motion (HS Movie)” (📷78).

Option	Image size Aspect ratio (horizontal to vertical)	Description
 HS 480/4x	640 × 480 4:3	1/4-speed slow motion movies • Max. recording time*: 15 seconds (playback time: 1 minute)
 HS 1080/0.5x	1920 × 1080 16:9	2x speed fast motion movies • Max. recording time*: 2 minutes (playback time: 1 minute)

- * While recording movies, the camera can be switched between normal speed movie recording and slow motion or fast motion movie recording.
The maximum recording time shown here refers only to the portion of the movie that is recorded in slow motion or fast motion.

Notes About HS Movie

- Sound is not recorded.
- Zoom position, focus, exposure, and white balance are locked when movie recording starts.

Playing Back in Slow Motion and Fast Motion

When recording at normal speed:

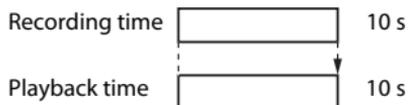

When recording at $\frac{480}{120}$ P HS 480/4x, or $\frac{480}{100}$ P HS 480/4x:

Movies are recorded at 4x normal speed.

They are played back in slow motion at 4x slower speed.

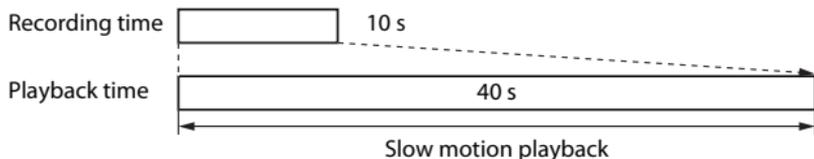

When recording at $\frac{1080}{120}$ P HS 1080/0.5x, or $\frac{1080}{120}$ P HS 1080/0.5x:

Movies are recorded at 1/2 normal speed.

They are played back in fast motion at 2x faster speed.

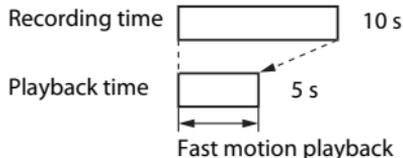

Recording Movies in Slow Motion and Fast Motion (HS Movie)

Enter shooting mode → MENU button →  menu icon → Movie options →  button

Movies recorded using HS movie can be played back in slow motion at 1/4 of the normal playback speed, or in fast motion at twice the normal playback speed.

1 Use the multi selector  to select an HS movie option () and press the  button.

- After applying the option, press the **MENU** button to return to the shooting screen.

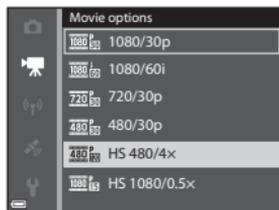

2 Press the  to start recording.

- The camera switches between normal speed movie recording and HS movie recording each time the  button is pressed.
- The movie options icon changes when switching between HS movie recording and normal speed movie recording.
- When the maximum recording time for HS movies () is reached, the camera automatically switches to normal speed movie recording.

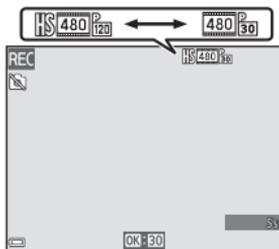

3 Press the  to end recording.

AF Area Mode

Enter shooting mode → MENU button →  menu icon → AF area mode →  button

Set how the camera selects the focus area for autofocus in short movie show mode or when recording movies.

Option	Description
 Face priority (default setting)	When the camera detects a human face, it focuses on that face. See “Using Face Detection” ( 16) for more information.
[] Center	The camera focuses on the subject in the center of the frame.

Notes About AF Area Mode for Movie Recording

AF area mode is set to focus on the center in the following situations even when **Face priority** is selected.

- When **Movie VR** is set to **On (hybrid)** and **Movie options** is set to  **1080/60i** or  **1080/50i**.
- When **Autofocus mode** in the movie menu is set to **Single AF** and no faces are detected before pressing the  button.
- When an HS movie option is selected in **Movie options**.

Autofocus Mode

Enter shooting mode → MENU button →  menu icon → Autofocus mode →  button

Set how the camera focuses in short movie show mode or when recording movies.

Option	Description
AF-S Single AF (default setting)	Focus is locked when movie recording starts. Select this option when the distance between the camera and the subject will remain fairly consistent.
AF-F Full-time AF	Camera focuses continuously. Select this option when the distance between the camera and subject will change significantly during recording. The sound of the camera focusing may be heard in the recorded movie. Use of Single AF is recommended to prevent the sound of the camera focusing from interfering with recording.

- When an HS movie option is selected in **Movie options**, the setting is fixed at **Single AF**.

Movie VR

Enter shooting mode → MENU button →  menu icon → Movie VR →  button

Set to reduce the effects of camera shake in short movie show mode or when recording movies.

Set this option to **Off** when using a tripod to stabilize the camera during recording.

Option	Description
 * On (hybrid) (default setting)	Performs optical compensation for camera shake using the lens shift method. Also performs electronic VR using image processing. The angle of view (i.e., the area visible in the frame) becomes narrower.
 On	Compensates for camera shake using the lens shift method.
Off	Compensation is not performed.

- When an HS movie option is selected in **Movie options, On (hybrid)** cannot be selected.

Notes About Movie VR

The effects of camera shake may not be completely eliminated in some situations.

Wind Noise Reduction

Enter shooting mode → MENU button →  menu icon → Wind noise reduction →  button

Option	Description
 On	Reduces the sound that is produced when wind passes over the microphone during movie recording. Other sounds may become difficult to hear during playback.
Off (default setting)	Wind noise reduction is disabled.

- When an HS movie option is selected in **Movie options**, the setting is fixed at **Off**.

Frame Rate

Enter shooting mode → MENU button →  menu icon → Frame rate →  button

Select the frame rate (fields per second for the interlaced format) used in short movie show mode or when recording movies. When the frame rate setting is switched, options that can be set in **Movie options** () change.

Option	Description
30 fps (30p/60i)	Suited for playback on a TV using the NTSC standard.
25 fps (25p/50i)	Suited for playback on a TV using the PAL standard.

The Playback Menu

- See “Editing Images (Still Images)” () for information about image editing functions.

Mark for Wi-Fi Upload

Press the  button (playback mode) → MENU button → Mark for Wi-Fi upload →  button

Select still images in the camera that you want to transfer to a smart device in advance before transferring them. Movies cannot be selected.

On the image selection screen ()53), select or deselect images for the **Mark for Wi-Fi upload** function.

Note that when you select **Reset all** ()105) in the setup menu or **Restore default settings** ()94) in the Wi-Fi options menu, the Mark for Wi-Fi upload settings that you made are canceled.

Slide Show

Press the  button (playback mode) → MENU button → Slide show →  button

Play back images one by one in an automated “slide show.” When movie files are played back in the slide show, only the first frame of each movie is displayed.

1 Use the multi selector to select **Start** and press the button.

- The slide show begins.
- To change the interval between images, select **Frame intvl**, press the  button, and specify the desired interval time before selecting **Start**.
- To repeat the slide show automatically, select **Loop** and press the  button before selecting **Start**.
- The maximum playback time is up to about 30 minutes even if **Loop** is enabled.

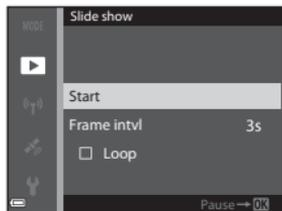

2 Select End or Restart.

- The screen shown on the right is displayed after the slide show ends or is paused. To exit the show, select  and then press the  button. To resume the slide show, select  and then press the  button.



Operations During Playback

- Use the multi selector  to display the previous/next image. Press and hold to rewind/fast forward.
- Press the  button to pause or end the slide show.

Protect

Press the  button (playback mode) → MENU button → Protect →  button

The camera protects selected images from accidental deletion.

Select images to protect or cancel protection from the image selection screen (53).

Note that formatting the memory card or the camera's internal memory permanently deletes all data including protected files (103).

Rotate Image

Press the  button (playback mode) → MENU button → Rotate image →  button

Specify the orientation in which saved images are displayed during playback. Still images can be rotated 90 degrees clockwise or 90 degrees counterclockwise.

Select an image from the image selection screen (53). When the Rotate image screen is displayed, use the multi selector  or rotate it to rotate the image 90 degrees.

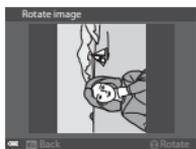

Rotate 90 degrees counterclockwise

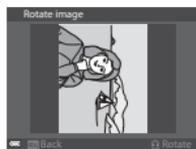

Rotate 90 degrees clockwise

Press the  button to finalize display orientation, and save orientation information with the image.

Copy (Copy Between the Memory Card and Internal Memory)

Press the  button (playback mode) → MENU button → Copy →  button

Images can be copied between a memory card and the internal memory.

- When a memory card that contains no images is inserted and the camera is switched to playback mode, **Memory contains no images.** is displayed. In that case, press the MENU button to select **Copy**.

- 1 Use the multi selector   to select a destination option to which images are copied and press the  button.

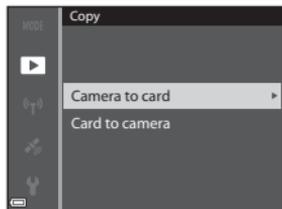

- 2 Select a copy option and press the  button.

- When you choose the **Selected images**, use the image selection screen to specify images (53).
- If you choose the **Card to camera** option, the All images option is not available.

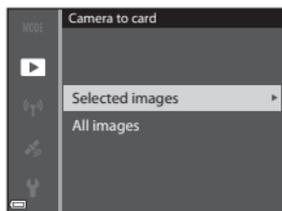

Notes About Copying Images

- Only files in formats that this camera can record can be copied.
- Operation is not guaranteed with images captured with another make of camera or that have been modified on a computer.

Copying Images in a Sequence

- If you select a key picture of a sequence in **Selected images**, all images in the sequence are copied.
- If you press the MENU button while images in a sequence are displayed, only the **Card to camera** copy option is available. All images in the sequence are copied if you select **Current sequence**.

Sequence Display Options

Press the  button (playback mode) → MENU button → Sequence display options →  button

Select the method used to display images in the sequence (24).

Option	Description
 Individual pictures	Displays each image in a sequence individually.  is displayed on the playback screen.
 Key picture only (default setting)	Displays only the key picture for images in a sequence.

The setting is applied to all sequences and saved in the camera's memory even if the camera is turned off.

The Location Data Options Menu

During the map display, you cannot select **Time zone and date**, **Format memory/Format card**, **Language**, and **Reset all** in the setup menu.

Location Data Options

Press the **MENU** button →  menu icon → Location data options →  button

Option	Description
Record location data	When set to On , signals are received from the positioning satellites, and positioning starts ( 32). <ul style="list-style-type: none">• Default setting: Off
Update A-GPS file	A memory card is used to update the A-GPS (assist GPS) file. Using the latest A-GPS file can shorten the time needed to perform positioning for the location data. <ul style="list-style-type: none">• See “Updating the A-GPS File” (87) for more information.
Erase location data	The location data and POI information recorded on images are erased. <ul style="list-style-type: none">• The deleted location data or POI information cannot be recovered.• The location data of images captured with cameras other than this camera cannot be erased.

Updating the A-GPS File

Download the latest A-GPS file from the website below, and use it to update the file.

<http://nikonimglib.com/agps3/>

- The A-GPS file for the COOLPIX S9900 is only available from the website above.

- 1** Download the latest A-GPS file to the computer from the website.

-
- 2 Use a card reader or other device to copy the downloaded file to the “NCFL” folder of the memory card.
 - The “NCFL” folder is located directly under the memory card root directory. If the memory card does not have “NCFL” folder, create a new folder.
 - 3 Insert the memory card containing the copied file into the camera.
 - 4 Turn on the camera.
 - 5 Press the **MENU** (menu) button to display the Location data options menu, and use the multi selector to select **Location data options**.
 - 6 Select **Update A-GPS file**, and update the file.
 - About two minutes are needed to update the A-GPS file.
-

 **Notes About Updating A-GPS File**

- The A-GPS file is disabled when a position is determined for the first time after the camera is purchased. The A-GPS file becomes active from the second operation for determining a location.
 - The validity period of the A-GPS file can be checked on the update screen. If the validity period has expired, it is displayed in gray.
 - Once the validity period of the A-GPS file has expired, performing positioning for the location data will not become faster. Updating of the A-GPS file before using the location data functions is recommended.
-

Distance Units

Press the **MENU** button →  menu icon → Distance units →  button

The distance units of the map display can be selected from **km (m)** (kilometers, meters) (default setting) or **mi (yd)** (miles, yards).

Calculate Distance

Press the  button (playback mode) → Display a map (35) → MENU button →  menu icon → Calculate distance →  button

Calculate the linear distance from the current position to the shooting location of the image or between the shooting locations of two images.

1 Use the multi selector   to select the desired option for calculating the distance, and press the  button.

- **Position now ↔ image:** Calculates the distance from the current position to the image shooting location. Confirmation of the current position starts. Proceed to step 3.
- **Image ↔ image:** Calculates the distance between the shooting locations of two images.

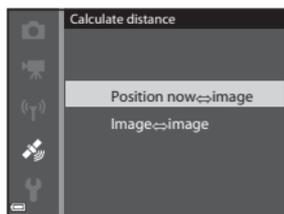

2 Use   to select the image that is the start point, and press the  button.

- To adjust the scale of the map, use the zoom control (**W** /**T** ).



3 Press   to select the image that is the end point.

- Each time an image is selected, the distance is displayed on the screen.
- To end distance calculation, press the  button.



Distance

Notes About Distance Calculation

- If the location data is not recorded on the image, the distance cannot be calculated.
- In order to calculate the distance using **Position now ↔ image**, the current position must have been obtained (32).

Points of Interest (POI) (Recording and Displaying Location Name Information)

Press the **MENU** button →  menu icon → Points of interest (POI) →  button

Configure the POI (points of interest, location name information) settings.

Option	Description
Embed POI	Set whether or not to record the location name information on the images to be shot. <ul style="list-style-type: none">• Default setting: Off• The location name information can be recorded on both still images and movies.
Display POI	Set whether or not to display the location name information on the shooting screen or playback screen (3, 5). <ul style="list-style-type: none">• If Embed POI was set to On when an image was captured, the location name information for the image is displayed on the playback screen.• Default setting: Off
Level of detail	Set the display level of the location name information. A higher display level shows more detailed regional information. <ul style="list-style-type: none">• When set to level 1: country names are displayed.• When set to levels 2 to 5: the information displayed varies depending on the country.• When set to level 6: landmark names (facilities) are displayed.
Edit POI	If Update POI is selected during playback mode, the location name information recorded on the image can be changed. Before pressing the MENU button, select the image to change the location name information. <ul style="list-style-type: none">• When level 6 is selected, press the multi selector  to change the landmark name.• To change the POI information level, press the multi selector . If Remove POI is selected, the location name information recorded on the image is deleted.



POI Display

If there is no location name information at the set display level, no information may be displayed.

Set Clock from Satellite

Press the **MENU** button →  menu icon → Set clock from satellite →  button

Signals from the positioning satellites are used to set the date and time of the camera's internal clock. Check the positioning status before setting the clock using this option.

Notes About Set Clock from Satellite

- To set the camera's internal clock, positioning must have been done successfully (32).
- Date/time adjustment by **Set clock from satellite** is set according to the time zone set in **Time zone and date** (95) of the setup menu. Check the time zone before setting **Set clock from satellite**.
- The date/time set using **Set clock from satellite** is not as accurate as radio clocks. Use **Time zone and date** in the setup menu to set the time if it is not accurate in **Set clock from satellite**.

Electronic Compass

Press the **MENU** button →  menu icon → Electronic compass →  button

Option	Description
Compass display	<p>Set whether or not to display a compass on the shooting screen.</p> <ul style="list-style-type: none">• Default setting: Off• The direction the camera is pointing is displayed based on measured direction information.• When the camera lens faces downward, the compass display switches to a circle compass with a red arrow that points north.<ul style="list-style-type: none">- Display style: north, east, south and west- Display range: 16 cardinal points

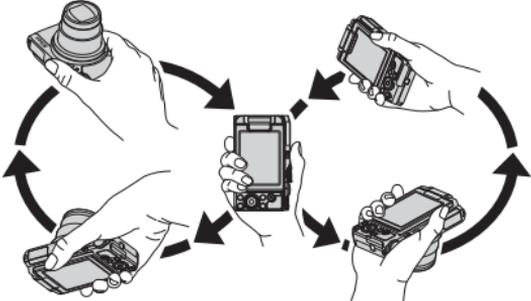
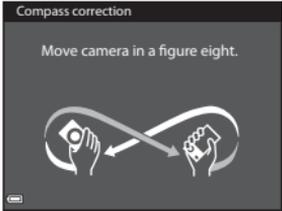
Option	Description
Compass correction	<p>Correct the compass when the compass direction is not displayed correctly. When the screen shown on the right is displayed, swing the camera to draw a figure eight in the air while turning your wrist to face the camera to face the camera forward and backward, side to side, or up and down.</p>  

Notes About Using the Electronic Compass

- The electronic compass is not displayed when the camera lens is facing upwards.
- Do not use the electronic compass in this camera for mountain climbing and other specialized applications. The displayed information is intended as a general guide only.
- Direction may not be measured correctly near the following objects: magnets, metals, electrical motors, electrical home appliances or electrical power cables.
- Direction may not be measured correctly in the following places: in automobiles, trains, ships, airplanes, inside buildings or in underground malls.
- Direction may not be measured correctly if the location data is not obtained.

The Wi-Fi Options Menu

Press the **MENU** button →  menu icon →  button

Configure the Wi-Fi (wireless LAN) settings to connect the camera and a smart device.

Option	Description
Connect to smart device	Select when wirelessly connecting the camera and a smart device. See "Connecting to a Smart Device (Wi-Fi)" () for more information.
Upload from camera	Select when wirelessly connecting the camera and a smart device. See "Preselecting Images in the Camera That You Want to Transfer to a Smart Device" () for more information. <ul style="list-style-type: none">The images to transfer can be selected on the image selection screen before establishing a Wi-Fi connection (, ). The SSID and password of the camera are displayed on the screen after images are selected.
Disable Wi-Fi	Select to terminate the wireless connection between the camera and a smart device. See "To Terminate the Wi-Fi Connection" () for more information.
Options	SSID: Change the SSID. The SSID configured here is displayed on the smart device. Set a 1- to 24-character alphanumeric SSID.
	Auth./encryp.: Select whether or not to encrypt the communications between the camera and the connected smart device. Communications are not encrypted when Open (default setting) is selected. <ul style="list-style-type: none">When WPA2-PSK-AES is set, the message for entering a password is displayed when the camera is connected to smart device (.
	Password: Set the password. Set an 8- to 16-character alphanumeric password.
	Channel: Select the channel used for wireless connections.
	Subnet mask: Use the default setting (255.255.255.0) under normal conditions.
	DHCP server IP address: Use the default setting (192.168.0.10) under normal conditions.

Option	Description
Current settings	Display the current settings.
Restore default settings	Restore the Wi-Fi settings to their default values.

Operating the Text Input Keyboard

Character Input for SSID and Password

- Use the multi selector ▲▼◀▶ to select alphanumeric characters. Press the **OK** button to enter the selected character in the text field and move the cursor to the next space.
- To move the cursor in the text field, select ← or → on the keyboard, and press the **OK** button.
- To delete one character, press the **⌫** button.
- To apply the setting, select ↵ on the keyboard and press the **OK** button.

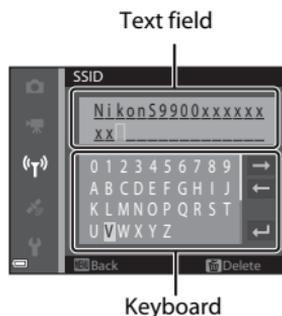

Character Input for Channel, Subnet mask and DHCP server IP address

- Use the multi selector ▲▼ to set the numbers. To move to the next digit, press ▶ or the **OK** button. To return to the previous digit, press ◀.
- To apply the setting, select the last digit and press the **OK** button.

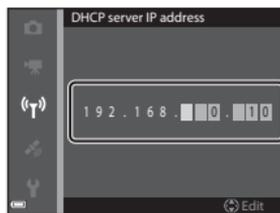

The Setup Menu

Time Zone and Date

Press the **MENU** button → **Y** menu icon → Time zone and date → **OK** button

Set the camera clock.

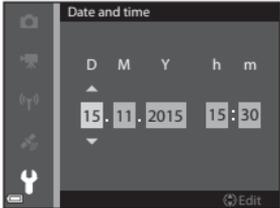
Option	Description
Date and time	<ul style="list-style-type: none">• Select a field: Press the multi selector ◀▶.• Edit the date and time: Press ▲▼. Date and time can also be changed by rotating the multi selector or command dial.• Apply the setting: Select the minute field setting and press the OK button. 
Date format	Select Year/Month/Day , Month/Day/Year , or Day/Month/Year .
Time zone	Set time zone and daylight saving time. <ul style="list-style-type: none">• When Travel destination (▶) is set after having set the home time zone (🏠), the time difference between the travel destination and the home time zone is automatically calculated, and the date and time are saved for the selected region.

Setting the Time Zone

- 1 Use the multi selector ▲▼ to select **Time zone** and press the **OK** button.

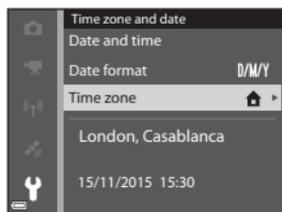

2 Select **Home time zone** or **Travel destination** and press the **OK** button.

- The date and time displayed in the monitor changes depending on whether the home time zone or travel destination is selected.

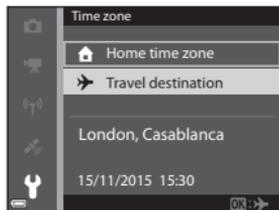

3 Press **▶**.

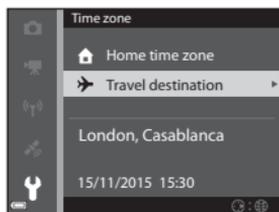

4 Use **◀▶** to select the time zone.

- Press **▲** to enable daylight saving time function, and **☀** is displayed. Press **▼** to disable the daylight saving time function.
- Press the **OK** button to apply the time zone.
- If the correct time is not displayed for the home or travel destination time zone setting, set the appropriate time in **Date and time**.

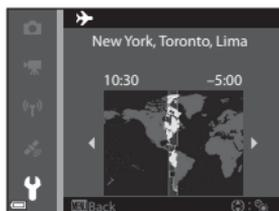

Monitor Settings

Press the **MENU** button → **Y** menu icon → Monitor settings → **OK** button

Option	Description
Photo info	Set whether or not to display information in the monitor.
Image review	Set whether or not to display the captured image is displayed immediately after shooting. <ul style="list-style-type: none">• Default setting: On
Brightness	Adjust the brightness. <ul style="list-style-type: none">• Default setting: 3

Photo info

	Shooting mode	Playback mode
Show info	 The monitor displays a scene with a woman in the foreground and a sailboat in the background. Various camera settings are overlaid on the screen, including 'P', '1/2000', 'F2.8', '23mm', '0.7', '10:50', '93%', and '33%'.	 The monitor displays the same scene as in shooting mode. The photo info overlay is present in the bottom right corner, showing 'OK: 1/2', '10:50', '93%', and '33%'.
Auto info (default setting)	The same information as shown in Show info is displayed, and it is hidden as shown in Hide info if no operations are performed for a few seconds. The information is displayed again when an operation is performed.	
Hide info	 The monitor displays the same scene as in shooting mode, but the photo info overlay is hidden.	 The monitor displays the same scene as in playback mode, but the photo info overlay is hidden.

Shooting mode

Playback mode

Framing
grid+auto info

In addition to the information shown in **Auto info**, a framing grid is displayed to help frame pictures. The framing grid is not displayed while recording movies.



Same as **Auto info**.

Movie
frame+auto
info

In addition to the information shown in **Auto info**, a frame is displayed before movie recording begins that represents the area that will be captured when recording movies. The movie frame is not displayed while recording movies.



Same as **Auto info**.

Date Stamp

Press the **MENU** button → **Y** menu icon → Date stamp → **OK** button

The shooting date and time can be stamped on images when shooting.



Option	Description
DATE Date	Date is stamped on images.
DATE Date and time	Date and time are stamped on images.
Off (default setting)	Date and time are not stamped on images.

Notes About Date Stamp

- Stamped dates form a permanent part of image data and cannot be deleted. The date and time cannot be stamped on images after they have been captured.
- The date and time cannot be stamped in the following situations:
 - When the scene mode is set to **Sports**, **Night portrait** (when set to **Hand-held**), **Night landscape** (when set to **Hand-held**), **Backlighting** (when **HDR** is **On**), **Easy panorama** or **Pet portrait** (when set to **Continuous**)
 - When **Blink proof** is set to **On** in smart portrait mode
 - When **Continuous** (65) is set
 - When recording movies
 - When saving still images during movie recording
- The stamped date and time may be difficult to read when using a small image size.

Printing a Shooting Date on Images Without a Date Stamp

You can transfer images to a computer and use the ViewNX 2 software (58) to imprint the shooting date on the images when they are printed.

Photo VR

Press the **MENU** button →  menu icon → Photo VR →  button

Select the vibration reduction setting used when shooting still images. Select **Off** when using a tripod to stabilize the camera during shooting.

Option	Description
 * On (hybrid)	Performs optical compensation for camera shake using the lens shift method. Under the following conditions, also performs electronic VR using image processing. <ul style="list-style-type: none">• Flash: Does not fire• Shutter speed: Slower than 1/30 second at the maximum wide-angle position and 1/250 second at the maximum telephoto position• Self-timer: OFF• Continuous setting: Single• ISO sensitivity: ISO 200 or lower The image recording time may be longer than usual.
 On (default setting)	Compensates for camera shake using the lens shift method.
Off	Compensation is not performed.

Notes About Photo VR

- After turning on the camera or after switching from playback mode to shooting mode, wait for the shooting screen to be displayed completely before taking pictures.
- Images displayed on the shooting screen immediately after shooting may be displayed blurry.
- The effects of camera shake may not be completely eliminated in some situations.
- When the shutter speed is extremely slow, images cannot be compensated using image processing even when **On (hybrid)** is set.

AF Assist

Press the MENU button →  menu icon → AF assist →  button

Option	Description
AUTO Auto (default setting)	The AF-assist illuminator automatically lights up when you press the shutter-release button under dim lighting. The illuminator has a range of about 5.0 m (16 ft) at the maximum wide-angle position and about 4.5 m (14 ft) at the maximum telephoto position. <ul style="list-style-type: none">Note that for some shooting modes or focus areas, the AF-assist illuminator may not light.
Off	The AF-assist illuminator does not light.

Digital Zoom

Press the MENU button →  menu icon → Digital zoom →  button

Option	Description
On (default setting)	Digital zoom is enabled.
 Crop	The zoom ratio is limited within a range in which the image quality does not deteriorate (17). <ul style="list-style-type: none">Digital zoom is not available when the image size is  4608×3456,  4608×2592, or  3456×3456.This setting functions in the same way as the On setting during movie recording.
Off	Digital zoom is disabled.

Notes About Digital Zoom

- Digital zoom cannot be used in the following shooting modes:
 - Portrait, Night portrait, Night landscape, Backlighting** (when **HDR** is set), **Easy panorama**, or **Pet portrait** scene mode
 - Smart portrait mode
- Digital zoom cannot be used in other shooting modes when using certain settings (46).

Sound Settings

Press the MENU button →  menu icon → Sound settings →  button

Option	Description
Button sound	When On (default setting) is selected, the camera produces one beep when operations are performed, two beeps when focus is acquired on the subject, and three beeps when an error occurs. The welcome screen sound is also produced. <ul style="list-style-type: none">• Sounds are disabled when using Pet portrait scene mode.
Shutter sound	When On (default setting) is selected, the shutter sound is produced when the shutter is released. <ul style="list-style-type: none">• The shutter sound is not produced when using continuous shooting mode, when recording movies, or when using Pet portrait scene mode.

Auto Off

Press the MENU button →  menu icon → Auto off →  button

Set the amount of time that elapses before the camera enters standby mode (15).

You can select **30 s**, **1 min** (default setting), **5 min**, or **30 min**.

Setting the Auto Off Function

The time that passes before the camera enters standby mode is fixed in the following situations:

- When shooting with **Pet portrait auto release**: 5 minutes (when auto off is set to **30 s** or **1 min**)
- When shooting with **Smile timer**: 5 minutes (when auto off is set to **30 s** or **1 min**)
- When a menu is displayed: 3 minutes (when auto off is set to **30 s** or **1 min**)
- When the AC adapter is connected: 30 minutes
- When an HDMI cable is connected: 30 minutes

Format Card/Format Memory

Press the MENU button →  menu icon → Format card/Format memory →  button

Use this option to format a memory card or the internal memory.

Formatting the memory cards or internal memory permanently deletes all data. Data that has been deleted cannot be recovered. Make sure to save important images to a computer before formatting.

Formatting a Memory Card

- Insert a memory card into the camera.
- Select **Format card** in the setup menu and then press the  button.

Formatting the Internal Memory

- Remove the memory card from the camera.
- Select **Format memory** in the setup menu and then press the  button.

To start formatting, select **Format** on the screen that is displayed and press the  button.

- Do not turn the camera off or open the battery-chamber/memory card slot cover during formatting.

Language

Press the MENU button →  menu icon → Language →  button

Select a language for display of camera menus and messages.

Charge by Computer

Press the MENU button →  menu icon → Charge by computer →  button

Option	Description
AUTO Auto (default setting)	When the camera is connected to a computer that is running (📖58), the battery inserted into the camera is automatically charged using power supplied by the computer.
Off	The battery inserted into the camera is not charged when the camera is connected to a computer.

Notes About Charging with a Computer

- When connected to a computer, the camera turns on and starts charging. If the camera is turned off, charging stops.
- About 4 hours and 10 minutes are required to charge a fully exhausted battery. Charging time increases when images are transferred while the battery is charging.
- The camera turns off automatically if there is no communication with the computer for 30 minutes after the battery has finished charging.

When the Charge Lamp Quickly Flashes Green

Charging cannot be performed, possibly due to one of the reasons described below.

- The ambient temperature is not suited to charging. Charge the battery indoors with an ambient temperature of 5°C to 35°C (41°F to 95°F).
- The USB cable is not connected correctly or the battery is faulty. Make sure the USB cable is connected correctly or replace the battery if necessary.
- The computer is in sleep mode and is not supplying power. Wake up the computer.
- The battery cannot be charged because the computer cannot supply power to the camera due to the computer's settings or its specifications.

Reset All

Press the **MENU** button → **Y** menu icon → **Reset all** → **OK** button

When **Reset all** is selected, the camera's settings are restored to their default values.

- Some settings, such as **Time zone and date** or **Language**, are not reset.

Resetting File Numbering

To reset file numbering to "0001", delete all images saved on the memory card or in the internal memory (📖19) before selecting **Reset all**.

Conformity Marking

Press the **MENU** button → **Y** menu icon → **Conformity marking** → **OK** button

View some of the conformity markings that the camera complies with.

Firmware Version

Press the **MENU** button → **Y** menu icon → **Firmware version** → **OK** button

View the current camera firmware version.

Error Messages

Refer to the table below if an error message is displayed.

Display	Cause/Solution	
Battery temperature is elevated. The camera will turn off.	The camera turns off automatically. Wait until the camera or battery temperature has cooled before resuming use.	-
The camera will turn off to prevent overheating.		
Memory card is write protected.	The write-protect switch is in the "lock" position. Slide the write-protect switch to the "write" position.	-
This card cannot be used.	An error occurred while accessing the memory card. <ul style="list-style-type: none"> • Use an approved memory card. • Check that the terminals are clean. • Confirm that the memory card is correctly inserted. 	7,  19
This card cannot be read.		
Card is not formatted. Format card?	The memory card has not been formatted for use in the camera. Formatting deletes all data saved on the memory card. If you need to keep copies of any images, make sure to select No and save the copies to a computer or other medium before formatting the memory card. Select Yes and press the  button to format the memory card.	7,  5
Out of memory.	Delete images or insert a new memory card.	7, 19
Image cannot be saved.	An error occurred while saving the image. Insert a new memory card or format the memory card or internal memory.	7,  103
	The camera has run out of file numbers. Insert a new memory card or format the memory card or internal memory.	7,  103
	There is insufficient space to save the copy. Delete images from the destination.	19
Image cannot be modified.	Check that the images can be edited.	 26,  12

Display	Cause/Solution	
Cannot record movie.	A time-out error occurred while saving the movie on the memory card. Select a memory card with a faster write speed.	 45,  19
Save previously recorded data as a time-lapse movie?	The camera turned off while recording time-lapse movie. <ul style="list-style-type: none"> • Select Yes to create a time-lapse movie with the previously captured images. • Select No to delete the incomplete data. 	–
Memory contains no images.	There are no images in the internal memory or on the memory card. <ul style="list-style-type: none"> • Remove the memory card to play back images in the internal memory. • To copy the images saved in the camera's internal memory to the memory card, press the MENU button to select Copy in the playback menu. 	7  85
File contains no image data.	The file was not created or edited with this camera.	–
This file cannot be played back.	The file cannot be viewed on this camera. View the file using a computer or the device used to create or edit this file.	
All images are hidden.	There are no images available for a slide show, etc.	–
This image cannot be deleted.	The image is protected. Disable protection.	 84
Raise the flash.	<ul style="list-style-type: none"> • When the scene mode is Scene auto selector, you can take a picture even if the flash is lowered but the flash will not fire. • When the scene mode is Night portrait or Backlighting with HDR set to Off, you must raise the flash to take a picture. 	 3  4,  6
Failed to set clock from satellite.	The camera clock was not set correctly. Change the location or time and determine the location again.	–

Display	Cause/Solution	
No A-GPS file found on card.	An A-GPS file that can be updated is not found on the memory card. Check the following items: <ul style="list-style-type: none"> • Whether the memory card is inserted • Whether the A-GPS file is stored on the memory card • Whether the A-GPS file saved on the memory card is more recent than the A-GPS file saved in the camera • Whether the A-GPS file is still valid 	-
Update failed.	Unable to update A-GPS file. The A-GPS file may be corrupted. Download the file from the website once more.	 87
Unable to determine current position.	Unable to determine the current position when distance is calculated. Change the location or time and determine the location again.	-
Cannot save to card.	A memory card is not inserted. Insert a memory card.	7
	The maximum number of log data events that can be saved per day is 36.	-
	No log data can be obtained.	 40
	The maximum number of log data events that can be saved in one memory card is 100. Replace the memory card with a new one or delete log data that is no longer required from a memory card.	 42
Unable to correct compass.	Unable to calibrate the electronic compass. Swing the camera to draw a figure eight in the air outdoors while turning your wrist to face the camera forward and backward, side to side, or up and down.	 92
No access.	The camera could not receive the communication signal from the smart device. Wirelessly connect the camera and smart device again. <ul style="list-style-type: none"> • Press the  button. • Touch an NFC-compatible smart device to the camera. • Select Connect to smart device in the Wi-Fi options menu. 	 50  51  50

Display	Cause/Solution	
Could not connect.	The camera failed to establish the connection while receiving the communication signals from the smart device. Select a different channel in Channel in Options in the Wi-Fi options menu and establish the wireless connection again.	 50,  93
Wi-Fi connection terminated.	The Wi-Fi connection is terminated in the following situations: <ul style="list-style-type: none"> • When the signal strength is insufficient • When the battery level is low • When a cable or memory card was removed and inserted Use a sufficiently charged battery, disconnect the TV, computer and printer, and then establish the wireless connection again.	 50,  93
Lens error. Try again after turning the camera off and on.	If the error persists, contact your retailer or Nikon-authorized service representative.	-
Communications error	An error occurred while communicating with the printer. Turn the camera off and reconnect the USB cable.	 54
System error	An error occurred in the camera's internal circuitry. Turn the camera off, remove and reinsert the battery, and turn the camera on. If the error persists, contact your retailer or Nikon-authorized service representative.	 7

Display	Cause/Solution	
Printer error: check printer status.	After solving the problem, select Resume and press the  button to resume printing.*	–
Printer error: check paper.	Load the specified size of paper, select Resume , and press the  button to resume printing.*	–
Printer error: paper jam.	Remove the jammed paper, select Resume , and press the  button to resume printing.*	–
Printer error: out of paper.	Load the specified size of paper, select Resume , and press the  button to resume printing.*	–
Printer error: check ink.	There is a problem with the printer's ink. Check the ink, select Resume , and press the  button to resume printing.*	–
Printer error: out of ink.	Replace the ink cartridge, select Resume , and press the  button to resume printing.*	–
Printer error: file corrupt.	There is a problem with the image file to be printed. Select Cancel and press the  button to cancel printing.	–

* See the documentation provided with your printer for further guidance and information.

File Names

Images, or movies are assigned file names as follows.

File name: DSCN0001.JPG

(1) (2) (3)

(1) Identifier	Not shown on the screen of the camera. <ul style="list-style-type: none">• DSCN: Original still images, movies, still images created by the movie editing function• SSCN: Small picture copies• RSCN: Cropped copies• FSCN: Images created by an image editing function other than crop and small picture, movies created by the movie editing function
(2) File number	Assigned in ascending order, starting with "0001" and ending with "9999."
(3) Extension	Indicates file format. <ul style="list-style-type: none">• .JPG: Still images• .MOV: Movies



Log Data Saved on Memory Cards

The log data is saved in the "NCFL" folder.

- The file names consist of "N", "date (the last two digits of the year, month, and day in YYYYMMDD format)", "identification number (0 to 9 or A to Z)" and "extension (.log)".
Example: the first location data log recorded on 15 May 2015 is N1505150.log
- Up to 36 files can be recorded a day and up to 100 files can be recorded on a memory card.

Optional Accessories

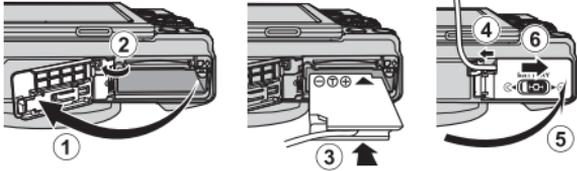
Battery Charger	Battery Charger MH-65 It takes about 2 hour and 30 minutes to charge a fully exhausted battery.
AC Adapter	AC Adapter EH-62F (connect as shown)  Make sure that the power connector cable is fully inserted in the power connector slot before inserting the AC adapter into the battery chamber. In addition, make sure that the power connector cable is fully inserted in the battery chamber slot before closing the battery-chamber/memory card slot cover. If part of the cable protrudes from the slots, the cover or cable may be damaged when the cover is closed.

Availability may vary with country or region.
See our website or brochures for the latest information.



Technical Notes and Index

Caring for the Product	2
The Camera.....	2
The Battery.....	3
The Charging AC Adapter	4
Memory Cards.....	5
Cleaning and Storage	6
Cleaning.....	6
Storage	6
Troubleshooting	7
Specifications	15
Approved Memory Cards	19
USER LICENSE AGREEMENT FOR MAP DATA AND LOCATION NAME DATA	21
Index	27

Caring for the Product

Observe the precautions described below in addition to the warnings in “For Your Safety” (📖vii-ix) when using or storing the device.

The Camera

Do Not Apply Strong Impact to the Camera

The product may malfunction if subjected to strong shock or vibration. In addition, do not touch or apply force to the lens or lens cover.

Keep Dry

The device will be damaged if immersed in water or subjected to high humidity.

Avoid Sudden Changes in Temperature

Sudden changes in temperature, such as when entering or leaving a heated building on a cold day, can cause condensation to form inside the device. To prevent condensation, place the device in a carrying case or a plastic bag before exposing it to sudden changes in temperature.

Keep Away from Strong Magnetic Fields

Do not use or store this device in the vicinity of equipment that generates strong electromagnetic radiation or magnetic fields. Doing so could result in loss of data or camera malfunction.

Do Not Point the Lens at Strong Light Sources for Extended Periods

Avoid pointing the lens at the sun or other strong light sources for extended periods when using or storing the camera. Intense light may cause the image sensor to deteriorate or produce a white blur effect in photographs.

Turn the Product Off Before Removing or Disconnecting the Power Source or Memory Card

Do not remove the battery while the product is on, or while images are being saved or deleted. Forcibly cutting power in these circumstances could result in loss of data or in damage to product memory or internal circuitry.

Notes About the Monitor

- Monitors and electronic viewfinders are constructed with extremely high precision; at least 99.99% of pixels are effective, with no more than 0.01% being missing or defective. Hence while these displays may contain pixels that are always lit (white, red, blue, or green) or always off (black), this is not a malfunction and has no effect on images recorded with the device.
- Images in the monitor may be difficult to see under bright lighting.
- Do not apply pressure to the monitor, as this could cause damage or malfunction. Should the monitor break, care should be taken to avoid injury caused by broken glass and to prevent the liquid crystal from the display touching the skin or entering the eyes or mouth.

The Battery

Precautions for Use

- Note that the battery may become hot after use.
- Do not use the battery at ambient temperatures below 0°C (32°F) or above 40°C (104°F) as this could cause damage or malfunction.
- If you notice any abnormalities such as excessive heat, smoke, or an unusual smell coming from the battery, immediately discontinue use and consult your retailer or Nikon-authorized service representative.
- After removing the battery from the camera or optional battery charger, put the battery in a plastic bag, etc. in order to insulate it.

Charging the Battery

Check the battery level before using the camera and replace or charge the battery if necessary.

- Charge the battery indoors with an ambient temperature of 5°C to 35°C (41°F to 95°F) before use.
- A high battery temperature may prevent the battery from charging properly or completely, and may reduce battery performance. Note that the battery may become hot after use; wait for the battery to cool before charging. When charging the battery inserted into this camera using the Charging AC Adapter or a computer, the battery is not charged at battery temperatures below 0°C (32°F) or above 45°C (113°F).
- Do not continue charging once the battery is fully charged as this will result in reduced battery performance.
- The battery temperature may increase during charging. However, this is not a malfunction.

Carrying Spare Batteries

Whenever possible, carry fully charged spare batteries when taking pictures on important occasions.

Using the Battery When Cold

On cold days, the capacity of batteries tends to decrease. If an exhausted battery is used at a low temperature, the camera may not turn on. Keep spare batteries in a warm place and exchange as necessary. Once warmed, a cold battery may recover some of its charge.

Battery Terminals

Dirt on the battery terminals may prevent the camera from functioning. Should the battery terminals become dirty, wipe them off with a clean, dry cloth before use.

Charging an Exhausted Battery

Turning the camera on or off while an exhausted battery is inserted in the camera may result in reduced battery life. Charge the exhausted battery before use.

Storing the Battery

- Always remove the battery from the camera or optional battery charger when it is not being used. Minute amounts of current are drawn from the battery while it is in the camera, even when not in use. This may result in excessive battery drain and complete loss of function.
- Recharge the battery at least once every six months and completely exhaust it before returning it to storage.
- Put the battery in a plastic bag, etc. in order to insulate it and store it in a cool place. The battery should be stored in a dry location with an ambient temperature of 15°C to 25°C (59°F to 77°F). Do not store the battery in hot or extremely cold locations.

Battery Life

A marked drop in the time a fully charged battery retains its charge, when used at room temperature, indicates that the battery needs to be replaced. Purchase a new battery.

Recycling Used Batteries

Replace the battery when it no longer holds a charge. Used batteries are a valuable resource. Please recycle used batteries in accordance with local regulations.

The Charging AC Adapter

- The Charging AC Adapter EH-71P is for use only with compatible devices. Do not use with another make or model of device.
- Do not use any USB cable other than the UC-E21. Using a USB cable other than the UC-E21 could result in overheating, fire or electric shock.
- Do not, under any circumstances, use another make or model of AC adapter other than Charging AC Adapter EH-71P, and do not use a commercially available USB-AC adapter or a battery charger for a mobile phone. Failure to observe this precaution could result in overheating or in damage to the camera.
- The EH-71P is compatible with AC 100-240 V, 50/60 Hz electrical outlets. When using in other countries, use a plug adapter (commercially available) as necessary. For more information about plug adapters, consult your travel agency.

Memory Cards

Precautions for Use

- Use only Secure Digital memory cards. See “Approved Memory Cards” (🔍:19) for recommended memory cards.
- Be sure to follow the precautions described in the documentation included with the memory card.
- Do not put labels or stickers on memory cards.

Formatting

- Do not format the memory card using a computer.
- The first time you insert a memory card that has been used in another device into this camera, be sure to format it with this camera. We recommend formatting new memory cards with this camera before using them with this camera.
- **Note that formatting a memory card permanently deletes all images and other data on the memory card.** Be sure to make copies of any images you wish to keep before formatting the memory card.
- If the message **Card is not formatted. Format card?** is displayed when the camera is turned on, the memory card must be formatted. If there is data that you do not want to delete, select **No**. Copy the necessary data to a computer, etc. If you want to format the memory card, select **Yes**. The confirmation dialog will be displayed. To start formatting, press the **OK** button.
- Do not perform the following during formatting, while data is being written to or deleted from the memory card, or during data transfer to a computer. Failure to observe this precaution could result in the loss of data or in damage to the camera or memory card:
 - Open the battery-chamber/memory card slot cover to remove/insert the battery or memory card.
 - Turn off the camera.
 - Disconnect the AC adapter.

Cleaning and Storage

Cleaning

Do not use alcohol, thinner, or other volatile chemicals.

Lens	Avoid touching glass parts with your fingers. Remove dust or lint with a blower (typically a small device with a rubber bulb attached to one end that is pumped to produce a stream of air out the other end). To remove fingerprints or other stains that cannot be removed with a blower, wipe the lens with a soft cloth, using a spiral motion that starts at the center of the lens and working toward the edges. If this fails, clean the lens using a cloth lightly dampened with commercial lens cleaner.
Monitor	Remove dust or lint with a blower. To remove fingerprints and other stains, clean the monitor with a soft, dry cloth, being careful not to apply pressure.
Body	<ul style="list-style-type: none">• Use a blower to remove dust, dirt, or sand, then wipe gently with a soft, dry cloth.• After using the camera at the beach or other sandy or dusty environment, wipe off any sand, dust, or salt with a dry cloth lightly dampened with fresh water and dry thoroughly. <p>Note that foreign matter inside the camera could cause damage not covered by the warranty.</p>

Storage

Remove the battery if the camera will not be used for an extended period. To prevent mold or mildew, take the camera out of storage at least once a month. Turn the camera on and release the shutter a few times before putting the camera away again. Do not store the camera in any of the following locations:

- Places that are poorly ventilated or subject to humidity of over 60%
- Exposed to temperatures above 50°C (122°F) or below -10°C (14°F)
- Next to equipment that produces strong electromagnetic fields, such as televisions or radios

For storing the battery, follow the precautions in “The Battery” (🔋:3) in “Caring for the Product” (🔧:2).

Troubleshooting

If the camera fails to function as expected, check the list of common problems below before consulting your retailer or Nikon-authorized service representative.

Power, Display, Settings Issues

Problem	Cause/Solution	
The camera is on but does not respond.	<ul style="list-style-type: none">• Wait for recording to end.• If the problem persists, turn the camera off. If the camera does not turn off, remove and reinsert the battery or batteries or, if you are using an AC adapter, disconnect and reconnect the AC adapter. <p>Note that although any data currently being recorded will be lost, data that have already been recorded will not be affected by removing or disconnecting the power source.</p>	–
The camera cannot be turned on.	<ul style="list-style-type: none">• The battery is exhausted.• The power switch is enabled a few seconds after the battery is inserted. Wait a few seconds before pressing the power switch.	7, 8,  3 –
The camera turns off without warning.	<ul style="list-style-type: none">• The camera automatically turns off to save power (auto off function).• The camera and battery may not work properly at low temperatures.• The inside of the camera has become hot. Leave the camera off until the inside of the camera has cooled, and then try turning it on again.	15  3 –
The monitor is blank.	<ul style="list-style-type: none">• The camera is off.• The camera automatically turns off to save power (auto off function).• The flash lamp flashes while the flash is charging. Wait until charging is complete.• The camera is connected to a TV or computer.• The camera and smart device are connected using Wi-Fi connection and the camera is operated by remote control.	11 15 16 – –
The camera becomes hot.	The camera may become hot when used for an extended period of time to record movies or send images, or when used in a hot environment; this is not a malfunction.	–

Problem	Cause/Solution	
The battery inserted in the camera cannot be charged.	<ul style="list-style-type: none"> • Confirm all connections. • When connected to a computer, the camera may not charge for any of the reasons described below. <ul style="list-style-type: none"> - Off is selected for Charge by computer in the setup menu. - Battery charging stops if the camera is turned off. - Battery charging is not possible if the camera's display language and date and time have not been set, or the date and time were reset after the camera's clock battery was exhausted. Use the Charging AC Adapter to charge the battery. - Battery charging may stop when the computer enters sleep mode. - Depending on the computer specifications, settings, and status, battery charging may not be possible. 	8 47, 54 – 11, 12 – –
The monitor is hard to read.	<ul style="list-style-type: none"> • Adjust the monitor brightness. • The monitor is dirty. Clean the monitor. 	47, 54  6
 flashes on the screen.	<ul style="list-style-type: none"> • If the camera clock has not been set,  flashes on the shooting screen, and images and movies saved before the clock is set are dated "00/00/0000 00:00" and "01/01/2015 00:00" respectively. Set the correct time and date for Time zone and date option in the setup menu. 	3, 47, 54
Date and time of recording are not correct.	<ul style="list-style-type: none"> • The camera clock is not as accurate as ordinary watches or clocks. Periodically compare the time of the camera clock with that of a more accurate timepiece and reset as required. 	
No indicators displayed in monitor.	Hide info is selected for Photo info in Monitor settings in the setup menu.	47, 54
Date stamp not available.	Time zone and date has not been set in the setup menu.	47, 54
Date not stamped on images even when Date stamp is enabled.	<ul style="list-style-type: none"> • The current shooting mode does not support Date stamp. • A function that restricts the date stamp is enabled. • The date cannot be stamped on movies. 	47, 54 44 –

Problem	Cause/Solution	
Screen for setting time zone and date is displayed when the camera is turned on.	The clock battery is exhausted; all settings were restored to their default values.	11, 12
The camera settings reset.		
The camera makes sound.	Depending on the Autofocus mode setting or the shooting mode, the camera may produce an audible focusing sound.	20, 47, 50, 51
Unable to select a menu.	<ul style="list-style-type: none"> Some functions cannot be used with other menu options. Some menus are not available when Wi-Fi is connected. Terminate the Wi-Fi connection. 	44  51

Shooting Issues

Problem	Cause/Solution	
Cannot switch to shooting mode.	Disconnect the HDMI cable or USB cable.	57
Cannot take pictures or record movies.	<ul style="list-style-type: none"> When the camera is in playback mode, press the  button, shutter-release button, or  button. When menus are displayed, press the MENU button. When the scene mode is Night portrait or Backlighting with HDR set to Off, raise the flash. The flash is charging while the flash lamp is flashing. The camera and smart device are connected using Wi-Fi connection and the camera is operated by remote control. The battery is exhausted. 	2, 18 48 23 16 56 7, 8,  3
	The camera cannot focus.	<ul style="list-style-type: none"> The subject is too close. Try shooting using Scene auto selector or Close-up scene mode, or macro mode. The subject is hard to focus on. Set AF assist in the setup menu to Auto. Turn the camera off and then on again.

Problem	Cause/Solution	
Images are blurred.	<ul style="list-style-type: none"> • Use the flash. • Increase the ISO sensitivity value. • Enable Photo VR when shooting still images. Enable Movie VR when recording movies. • Use a tripod to stabilize the camera (using the self-timer at the same time is more effective). 	16, 35 47, 49 47, 51, 54 37
Bright specks appear in images captured with flash.	The flash is reflecting off particles in the air. Lower the flash, and set the flash mode setting to  (off).	35
Flash does not fire.	<ul style="list-style-type: none"> • A shooting mode that restricts the flash is selected. • A function that restricts the flash is enabled. 	 14 44
Digital zoom cannot be used.	<ul style="list-style-type: none"> • Digital zoom is set to Off or Crop in the setup menu. • Digital zoom cannot be used with certain shooting modes or when using certain settings in other functions. 	47, 54 46, 54
Image size not available.	<ul style="list-style-type: none"> • A function that restricts the Image size option is enabled. • When the scene mode is set to Easy panorama, the image size is fixed. 	44  11
No sound when the shutter is released.	Off is selected for Shutter sound in Sound settings in the setup menu. No sound is produced with some shooting modes and settings, even when On is selected.	46, 54
AF-assist illuminator does not light.	Off is selected for the AF assist option in the setup menu. AF-assist illuminator may not light depending on the position of the focus area or the current shooting mode, even when Auto is selected.	47, 54
Images appear smeared.	The lens is dirty. Clean the lens.	 6
Colors are unnatural.	White balance or hue is not adjusted properly.	47, 49,  5
Randomly spaced bright pixels ("noise") appear in image.	The subject is dark and the shutter speed is too slow or ISO sensitivity is too high. Noise can be reduced by: <ul style="list-style-type: none"> • Using the flash • Specifying a lower ISO sensitivity setting 	16, 35 47, 49

Problem	Cause/Solution	
Images are too dark (underexposed).	<ul style="list-style-type: none"> The flash window is blocked. The subject is beyond the range of the flash. Adjust exposure compensation. Increase ISO sensitivity. The subject is backlit. Raise the flash, or set the scene mode to Backlighting with HDR set to Off. 	13  16 40, 43 47, 49 35,  6
Images are too bright (overexposed).	Adjust exposure compensation.	40, 43
Unexpected results when flash set to  (auto with red-eye reduction/red-eye reduction).	Use any scene mode other than Night portrait , and change the flash mode to any setting other than  (auto with red-eye reduction/red-eye reduction) and try taking the picture again.	35,  14
Skin tones are not softened.	<ul style="list-style-type: none"> In some shooting conditions, facial skin tones may not be softened. For images containing 4 or more faces, try using the Skin softening effect in Glamour retouch in the playback menu. 	 17 47, 52
Saving images takes time.	It may take more time to save images in the following situations: <ul style="list-style-type: none"> When the noise reduction function is in operation, such as when shooting in a dark environment When the flash mode is set to  (auto with red-eye reduction/red-eye reduction) When capturing images in the following scene modes <ul style="list-style-type: none"> Hand-held in Night portrait Hand-held in Night landscape HDR set to On in Backlighting Easy panorama When the skin softening function is applied while shooting When using continuous shooting mode 	– 36  4  5  6  11 47,  17 47, 49
A ring-shaped belt or rainbow-colored stripe appears in the monitor or images.	When shooting with backlighting or when a very strong light source (such as sunlight) is in the frame, a ring-shaped belt or rainbow-colored stripe (ghosting) may occur. Change the position of the light source, or frame the picture so that the light source does not enter the frame, and try again.	–

Playback Issues

Problem	Cause/Solution	
File cannot be played back.	<ul style="list-style-type: none"> • This camera may not be able to play back images saved with another make or model of digital camera. • This camera cannot play back movies recorded with another make or model of digital camera. • This camera may not be able to play back data edited on a computer. 	–
Cannot zoom in on image.	<ul style="list-style-type: none"> • Playback zoom cannot be used with movies. • This camera may not be able to zoom in on images captured with another make or model of digital camera. • When zooming in on a small-sized image, the magnification rate shown on the screen may differ from the actual magnification rate of the image. 	–
Cannot edit image.	<ul style="list-style-type: none"> • Some images cannot be edited. Images that have already been edited may not be edited again. • There is not enough free space on the memory card or in the internal memory. • This camera is unable to edit images captured with other cameras. • Editing functions used for images are not available for movies. 	 13,  26 – – –
Cannot rotate image.	This camera cannot rotate images captured with another make or model of digital camera.	–
Images are not displayed on TV.	<ul style="list-style-type: none"> • A computer or printer is connected to the camera. • The memory card contains no images. • Remove the memory card to play back images in the internal memory. 	– – 7
Nikon Transfer 2 does not start when the camera is connected to a computer.	<ul style="list-style-type: none"> • The camera is off. • The battery is exhausted. • The USB cable is not correctly connected. • The camera is not recognized by the computer. • The computer is not set to start Nikon Transfer 2 automatically. For more information about Nikon Transfer 2, refer to help information contained in ViewNX 2. 	– 47, 54, 57 57,  58 – –

Problem	Cause/Solution	
The PictBridge startup screen is not displayed when the camera is connected to a printer.	With some PictBridge-compatible printers, the PictBridge startup screen may not be displayed and it may be impossible to print images when Auto is selected for Charge by computer in the setup menu. Set the Charge by computer to Off and reconnect the camera to the printer.	47, 54
Images to be printed are not displayed.	<ul style="list-style-type: none"> The memory card contains no images. Remove the memory card to print images in the internal memory. 	- 7
Cannot select paper size with the camera.	<p>The camera cannot be used to select the paper size in the following situations, even when printing from a PictBridge-compatible printer. Use the printer to select the paper size.</p> <ul style="list-style-type: none"> The printer does not support the paper sizes specified by the camera. The printer automatically selects the paper size. 	-

Location Data Functions

Problem	Cause/Solution	
Unable to identify the location or it takes time to identify the location.	<ul style="list-style-type: none"> The camera may not be able to identify the location in some shooting environments. To use the location data functions, use the camera as much as possible in an open-air area. When positioning for the first time or when positioning was unable to be performed for about 2 hours, it takes a few minutes to obtain the location data. 	 33
Unable to record location data on shot images.	When  or  is displayed on the shooting screen, the location data is not recorded. Before shooting images, check the location data reception.	 34
Difference between the actual shooting location and recorded location data.	The acquired location data may deviate in some shooting environments. When there is a significant difference in the signals from the positioning satellites, there could be a deviation of up to several hundred meters.	 33

Problem	Cause/Solution	
The recorded location name is different from the intended one or is not displayed.	The desired landmark name may not be registered, or a different landmark name may be registered.	-
Unable to update the A-GPS file.	<ul style="list-style-type: none"> • Check the following items. <ul style="list-style-type: none"> - Whether the memory card is inserted - Whether the A-GPS file is stored on the memory card - Whether the A-GPS file saved on the memory card is more recent than the A-GPS file saved in the camera - Whether the A-GPS file is still valid • The A-GPS file may be corrupted. Download the file from the website once more. 	- 47
Unable to display the map.	Maps cannot be displayed while the camera is being charged with the Charging AC Adapter, even if the  (map) button is pressed.	-
Unable to select Create log in the Location data options menu.	Clock not set. Set date and time.	47, 54
Unable to select Start log .	<ul style="list-style-type: none"> • Record location data in the Location data options menu is set to Off. • The camera is recording log data. To record a new log, select End log, and end the log currently being recorded. 	47
Unable to save log data.	<ul style="list-style-type: none"> • Make sure that a memory card is inserted in the camera. • Up to 36 log data events can be recorded per day. • No log data can be obtained. • The total number of log data events that can be saved on a single memory card is up to 100. Delete log data that is no longer required from a memory card or replace the memory card with a new one. 	- -  40 47,  41,  42

Specifications

Nikon COOLPIX S9900 Digital Camera

Type	Compact digital camera
Number of effective pixels	16.0 million (Image processing may reduce the number of effective pixels.)
Image sensor	1/2.3-in. type CMOS; approx. 16.76 million total pixels
Lens	NIKKOR lens with 30× optical zoom
Focal length	4.5–135 mm (angle of view equivalent to that of 25–750 mm lens in 35mm [135] format)
f/-number	f/3.7–6.4
Construction	13 elements in 11 groups (3 ED lens elements)
Digital zoom magnification	Up to 4× (angle of view equivalent to that of approx. 3000 mm lens in 35mm [135] format)
Vibration reduction	Combination of lens shift and electronic VR
Autofocus (AF)	Contrast-detect AF
Focus range	<ul style="list-style-type: none">• [W]: Approx. 50 cm (1 ft 8 in.)–∞, [T]: Approx. 2 m (6 ft 7 in.)–∞• Macro mode: Approx. 1 cm (0.4 in.)–∞ (wide-angle position) (All distances measured from center of front surface of lens)
Focus-area selection	Face priority, manual with 99 focus areas, center, subject tracking, target finding AF
Monitor	7.5 cm (3-in.), approx. 921k-dot (RGBW), wide viewing angle TFT LCD with anti-reflection coating and 6-level brightness adjustment, vari-angle TFT LCD
Frame coverage (shooting mode)	Approx. 98% horizontal and vertical (compared to actual picture)
Frame coverage (playback mode)	Approx. 100% horizontal and vertical (compared to actual picture)
Storage	
Media	Internal memory (approx. 473 MB) SD/SDHC/SDXC memory card
File system	DCF and Exif 2.3 compliant
File formats	Still images: JPEG Movies: MOV (Video: H.264/MPEG-4 AVC, Audio: LPCM stereo)

Image size (pixels)	<ul style="list-style-type: none"> • 16M 4608×3456 • 8M 3264×2448 • 4M 2272×1704 • 2M 1600×1200 • VGA 640×480 • 16:9 12M 4608×2592 • 1:1 3456×3456
ISO sensitivity (Standard output sensitivity)	<ul style="list-style-type: none"> • ISO 125–1600 • ISO 3200, 6400 (available when using P, S, A, or M mode)
Exposure	
Metering mode	Matrix, center-weighted, spot (digital zoom 2× or more)
Exposure control	Programmed auto exposure with flexible program, shutter-priority auto, aperture-priority auto, manual, and exposure compensation (–2.0–+2.0 EV in steps of 1/3 EV)
Shutter	Mechanical and CMOS electronic shutter
Speed	<ul style="list-style-type: none"> • 1/2000–1 s • 1/2000–8 s (when ISO sensitivity is fixed at ISO 125 or 200 in S, A*, or M mode) • 1/4000 s (maximum speed during high-speed continuous shooting) • 4 s (Fireworks show scene mode) <p>* When the aperture value is f/5.6–8 at the wide-angle position</p>
Aperture	Electronically-controlled 3-blade iris diaphragm
Range	14 steps of 1/6 EV (W) (A , M mode)
Self-timer	Can be selected from 10 s and 2 s
Flash	
Range (approx.) (ISO sensitivity: Auto)	[W]: 0.5–6.0 m (1 ft 8 in.–19 ft) [T]: 1.5–3.5 m (5–11 ft)
Flash control	TTL auto flash with monitor preflashes
Interface	
USB connector	Micro-USB connector (Do not use any USB cable other than the UC-E21.), Hi-Speed USB <ul style="list-style-type: none"> • Supports Direct Print (PictBridge)
HDMI output connector	HDMI micro connector (Type D)

Wi-Fi (Wireless LAN)	
Standards	IEEE 802.11b/g/n (standard wireless LAN protocol)
Range (line of sight)	Approx. 10 m (10 yd)
Operating frequency	2412–2462 MHz (1–11 channels)
Data rates (actual measured values)	IEEE 802.11b: 5 Mbps IEEE 802.11g: 15 Mbps IEEE 802.11n: 15 Mbps
Security	OPEN/WPA2
Access protocols	Infrastructure
Electronic compass	16 cardinal points (position correction using 3-axis acceleration sensor, automatic correction for the deviated angle, and automatic offset adjustment)
Location data	<ul style="list-style-type: none"> • GPS Receiving frequency: 1575.42 MHz Geodetic system: WGS 84 • GLONASS Receiving frequency: 1598.0625–1605.3750 MHz Geodetic system: WGS 84
Supported languages	Arabic, Bengali, Bulgarian, Chinese (Simplified and Traditional), Czech, Danish, Dutch, English, Finnish, French, German, Greek, Hindi, Hungarian, Indonesian, Italian, Japanese, Korean, Marathi, Norwegian, Persian, Polish, Portuguese (European and Brazilian), Romanian, Russian, Serbian, Spanish, Swedish, Tamil, Telugu, Thai, Turkish, Ukrainian, Vietnamese
Power sources	One Rechargeable Li-ion Battery EN-EL12 (included) AC Adapter EH-62F (available separately)
Charging time	Approx. 2 h 20 min (when using Charging AC Adapter EH-71P and when no charge remains)
Battery life¹	
Still images	Approx. 300 shots when using EN-EL12
Movies (actual battery life for recording) ²	Approx. 1 h (1080/30p) when using EN-EL12 Approx. 1 h 5 min (1080/25p) when using EN-EL12
Tripod socket	1/4 (ISO 1222)
Dimensions (W × H × D)	Approx. 112.0 × 66.0 × 39.5 mm (4.5 × 2.6 × 1.6 in.) (excluding projections)
Weight	Approx. 289 g (10.2 oz) (including battery and memory card)

Operating environment

Temperature	0°C–40°C (32°F–104°F)
Humidity	85% or less (no condensation)

- Unless otherwise stated, all figures assume a fully-charged battery and an ambient temperature of $23 \pm 3^{\circ}\text{C}$ ($73.4 \pm 5.4^{\circ}\text{F}$) as specified by the Camera and Imaging Products Association (CIPA).
- ¹ Battery life may vary depending on conditions of use, such as the interval between shots or the length of time that menus and images are displayed.
 - ² Individual movie files cannot exceed 4 GB in size or 29 minutes in length. Recording may end before this limit is reached if camera temperature becomes elevated.

Rechargeable Li-ion Battery EN-EL12

Type	Rechargeable lithium-ion battery
Rated capacity	DC 3.7 V, 1050 mAh
Operating temperature	0°C–40°C (32°F–104°F)
Dimensions (W × H × D)	Approx. 32 × 43.8 × 7.9 mm (1.3 × 1.7 × 0.3 in.)
Weight	Approx. 22.5 g (0.8 oz)

Charging AC Adapter EH-71P

Rated input	AC 100–240 V, 50/60 Hz, MAX 0.2 A
Rated output	DC 5.0 V, 1.0 A
Operating temperature	0°C–40°C (32°F–104°F)
Dimensions (W × H × D)	Approx. 55 × 22 × 54 mm (2.2 × 0.9 × 2.2 in.) (excluding plug adapter) For Argentina: Approx. 55 × 63 × 59 mm (2.2 × 2.5 × 2.4 in.) For Brazil: Approx. 55 × 67 × 59 mm (2.2 × 2.7 × 2.4 in.)
Weight	Approx. 48 g (1.7 oz) (excluding plug adapter) For Argentina: Approx. 73 g (2.6 oz) For Brazil: Approx. 70 g (2.5 oz)

- Nikon will not be held liable for any errors this manual may contain.
- The appearance of this product and its specifications are subject to change without notice.

Approved Memory Cards

The following Secure Digital (SD) memory cards have been tested and approved for use in this camera.

- Memory cards with an SD Speed Class rating of 6 or faster are recommended for recording movies. When using a memory card with a lower Speed Class rating, movie recording may stop unexpectedly.

	SD memory card	SDHC memory card	SDXC memory card
SanDisk	2 GB	4 GB, 8 GB, 16 GB, 32 GB	64 GB, 128 GB
TOSHIBA	–	4 GB, 8 GB, 16 GB, 32 GB	64 GB
Panasonic	2 GB	4 GB, 8 GB, 16 GB, 32 GB	64 GB
Lexar	–	4 GB, 8 GB, 16 GB, 32 GB	64 GB, 128 GB

- Contact the manufacturer for details on the above cards. We cannot guarantee camera performance when using memory cards made by other manufacturers.
- If you use a card reader, make sure that it is compatible with your memory card.

Trademark Information

- Windows is either a registered trademark or trademark of Microsoft Corporation in the United States and/or other countries.
- Adobe, the Adobe logo, and Reader are either trademarks or registered trademarks of Adobe Systems Incorporated in the United States and/or other countries.
- SDXC, SDHC, and SD Logos are trademarks of SD-3C, LLC.



- PictBridge is a trademark.
- HDMI, HDMI logo and High-Definition Multimedia Interface are trademarks or registered trademarks of HDMI Licensing LLC.

HDMI

- Wi-Fi and the Wi-Fi logo are trademarks or registered trademarks of the Wi-Fi Alliance.
- Android and Google Play are trademarks or registered trademarks of Google, Inc.
- The N-Mark is a trademark or registered trademark of NFC Forum, Inc. in the United States and in other countries.
- All other trade names mentioned in this manual or the other documentation provided with your Nikon product are trademarks or registered trademarks of their respective holders.

AVC Patent Portfolio License

This product is licensed under the AVC Patent Portfolio License for the personal and non-commercial use of a consumer to (i) encode video in compliance with the AVC standard (“AVC video”) and/or (ii) decode AVC video that was encoded by a consumer engaged in a personal and non-commercial activity and/or was obtained from a video provider licensed to provide AVC video. No license is granted or shall be implied for any other use. Additional information may be obtained from MPEG LA, L.L.C.

See <http://www.mpegla.com>.

FreeType License (FreeType2)

Portions of this software are copyright © 2012 The FreeType Project (<http://www.freetype.org>). All rights reserved.

MIT License (HarfBuzz)

Portions of this software are copyright © 2015 The HarfBuzz Project (<http://www.freedesktop.org/wiki/Software/HarfBuzz>). All rights reserved.

USER LICENSE AGREEMENT FOR MAP DATA AND LOCATION NAME DATA

The map data and location name data that are stored in this digital camera ("Data") is provided for your personal, internal use only and not for resale. It is protected by copyright, and is subject to the following terms and conditions which are agreed to by you, on the one hand, and Nikon Corporation ("Nikon") and its licensors (including their licensors and suppliers) on the other hand.

Terms and Conditions

Personal Use Only. You agree to use this Data together with this digital camera and the image data taken by the digital camera for the solely personal, non-commercial purposes for which you were licensed, and not for service bureau, time-sharing or other similar purposes.

Accordingly, but subject to the restrictions set forth in the following paragraphs, you agree not to otherwise reproduce, copy, modify, decompile, disassemble or reverse engineer any portion of this Data, and may not transfer or distribute it in any form, for any purpose, except to the extent permitted by mandatory laws.

Restrictions. Except where you have been specifically licensed to do so by Nikon, and without limiting the preceding paragraph, you may not (a) use this Data with any products, systems, or applications installed or otherwise connected to or in communication with vehicles, capable of vehicle navigation, positioning, dispatch, real time route guidance, fleet management or similar applications; or (b) with or in communication with any positioning devices or any mobile or wireless-connected electronic or computer devices, including without limitation cellular phones, palmtop and handheld computers, pagers, and personal digital assistants or PDAs.

Warning. The Data may contain inaccurate or incomplete information due to the passage of time, changing circumstances, sources used and the nature of collecting comprehensive geographic data, any of which may lead to incorrect results.

No Warranty. This Data is provided to you "as is," and you agree to use it at your own risk. Nikon and its licensors (and their licensors and suppliers) make no guarantees, representations or warranties of any kind, express or implied, arising by law or otherwise, including but not limited to, content, quality, accuracy, completeness, effectiveness, reliability, fitness for a particular purpose, usefulness, use or results to be obtained from this Data, or that the Data or server will be uninterrupted or error-free.

Disclaimer of Warranty: NIKON AND ITS LICENSORS (INCLUDING THEIR LICENSORS AND SUPPLIERS) DISCLAIM ANY WARRANTIES, EXPRESS OR IMPLIED, OF QUALITY, PERFORMANCE, MERCHANTABILITY, FITNESS FOR A PARTICULAR PURPOSE OR NON-INFRINGEMENT. Some States, Territories and Countries do not allow certain warranty exclusions, so to that extent the above exclusion may not apply to you.

Disclaimer of Liability: NIKON AND ITS LICENSORS (INCLUDING THEIR LICENSORS AND SUPPLIERS) SHALL NOT BE LIABLE TO YOU: IN RESPECT OF ANY CLAIM, DEMAND OR ACTION, IRRESPECTIVE OF THE NATURE OF THE CAUSE OF THE CLAIM, DEMAND OR ACTION ALLEGING ANY LOSS, INJURY OR DAMAGES, DIRECT OR INDIRECT, WHICH MAY RESULT FROM THE USE OR POSSESSION OF THE INFORMATION; OR FOR ANY LOSS OF PROFIT, REVENUE, CONTRACTS OR SAVINGS, OR ANY OTHER DIRECT, INDIRECT, INCIDENTAL, SPECIAL OR CONSEQUENTIAL DAMAGES ARISING OUT OF YOUR USE OF OR INABILITY TO USE THIS INFORMATION, ANY DEFECT IN THE INFORMATION, OR THE BREACH OF THESE TERMS OR CONDITIONS, WHETHER IN AN ACTION IN CONTRACT OR TORT OR BASED ON A WARRANTY, EVEN IF NIKON OR ITS LICENSORS HAVE BEEN ADVISED OF THE POSSIBILITY OF SUCH DAMAGES. Some States, Territories and Countries do not allow certain liability exclusions or damages limitations, so to that extent the above may not apply to you.

Export Control. You agree not to export from anywhere any part of the Data or any direct product thereof except in compliance with, and with all licenses and approvals required under, applicable export laws, rules and regulations, including but not limited to the laws, rules and regulations administered by the Office of Foreign Assets Control of the U.S. Department of Commerce and the Bureau of Industry and Security of the U.S. Department of Commerce. To the extent that any such export laws, rules or regulations prohibit Nikon and its licensors from complying with any of its obligations hereunder to deliver or distribute Data, such failure shall be excused and shall not constitute a breach of this Agreement.

Entire Agreement. These terms and conditions constitute the entire agreement between Nikon (and its licensors, including their licensors and suppliers) and you pertaining to the subject matter hereof, and supersedes in their entirety any and all written or oral agreements previously existing between us with respect to such subject matter.

Governing Law. The above terms and conditions shall be governed by the laws of the Japan, without giving effect to (i) its conflict of laws provisions, or (ii) the United Nations Convention for Contracts for the International Sale of Goods, which is explicitly excluded; provided that in the event that the laws of the Japan is not deemed applicable to this Agreement for any reason in the country where you obtained the Data, this Agreement shall be governed with the laws of the country where you obtained the Data. You agree to submit to the jurisdiction of Japan for any and all disputes, claims and actions arising from or in connection with the Data provided to you hereunder.

Government End Users. If the Data supplied by HERE is being acquired by or on behalf of the United States government or any other entity seeking or applying rights similar to those customarily claimed by the United States government, the Data is a "commercial item" as that term is defined at 48 C.F.R. ("FAR") 2.101, is licensed in accordance with the End-User Terms under which this Data was provided, and each copy of the Data delivered or otherwise furnished shall be marked and embedded as appropriate with the following "Notice of Use," and shall be treated in accordance with such Notice:

NOTICE OF USE
CONTRACTOR (MANUFACTURER/ SUPPLIER) NAME:
HERE
CONTRACTOR (MANUFACTURER/ SUPPLIER) ADDRESS:
425 West Randolph Street, Chicago, Illinois 60606
This Data is a commercial item as defined in
FAR 2.101 and is subject to the End-User
Terms under which this Data was provided.
© 2014 HERE - All rights reserved.

If the Contracting Officer, federal government agency, or any federal official refuses to use the legend provided herein, the Contracting Officer, federal government agency, or any federal official must notify HERE prior to seeking additional or alternative rights in the Data.

Notices related to licensed software copyright holders.

- Map data and location name data for Japan



© 2014 ZENRIN CO., LTD. All rights reserved.
This service uses map and POI data of ZENRIN CO., LTD.
"ZENRIN" is a registered trademark of ZENRIN CO., LTD.

- Map data and location name data except for Japan



Maps for Life

© 1987-2014 HERE
All rights reserved.

Austria: © Bundesamt für Eich- und Vermessungswesen

Belgium: © - Distribution & Copyright CIRB

Croatia/Cyprus/Estonia/Latvia/Lithuania/Moldova/Poland/Slovenia/Ukraine: © EuroGeographics

Denmark: Contains data that is made available by the Danish Geodata Agency (FOT) Retrieved by HERE 01/2014

Finland: Contains data from the National Land Survey of Finland Topographic Database 06/2012. (Terms of Use available at http://www.maanmittauslaitos.fi/en/NLS_open_data_licence_version1_20120501).

Contains data that is made available by Itella in accordance with the terms available at http://www.itella.fi/liitteet/palvelutjatuotteet/yhteystietopalvelut/uusi_postal_code_services_service_description_and_terms_of_use.pdf. Retrieved by HERE 09/2013

France: source: © IGN 2009 – BD TOPO ©

Germany: Die Grundlagendaten wurden mit Genehmigung der zuständigen Behörden entnommen. Contains content of „Bayrische Vermessungsverwaltung – www.geodaten.bayern.de“, licensed in accordance with <http://creativecommons.org/licenses/by/3.0/legalcode>

Contains content of "LGL, www.lgl-bw.de", licensed in accordance with <http://creativecommons.org/licenses/by/3.0/legalcode>

Contains content of "Stadt Köln – offenedaten-koeln.de", licensed in accordance with <http://creativecommons.org/licenses/by/3.0/legalcode>

Contains Content of "Geoportal Berlin / ATKIS® Basis-DLM", licensed in accordance with <http://www.stadtentwicklung.berlin.de/geoinformation/download/nutz3ll.pdf>

Contains Content of "Geoportal Berlin / Karte von Berlin 1:5000 (K5-Farbausgabe)", licensed in accordance with <http://www.stadtentwicklung.berlin.de/geoinformation/download/nutz3ll.pdf>

Great Britain: Contains Ordnance Survey data © Crown copyright and database right 2010

Contains Royal Mail data © Royal Mail copyright and database right 2010

Greece: Copyright Geomatics Ltd.

Italy: La Banca Dati Italiana è stata prodotta usando quale riferimento anche cartografia numerica ed al tratto prodotta e fornita dalla Regione Toscana.

Contains data from Trasporto Passeggeri Emilia-Romagna- S.p.A.

Includes content of Comune di Bologna licensed under <http://creativecommons.org/licenses/by/3.0/legalcode> and updated by licensee July 1, 2013.

Includes content of Comune di Cesena licensed under <http://creativecommons.org/licenses/by/3.0/legalcode> and updated by licensee July 1, 2013.

Includes contents of Ministero della Salute, and Regione Sicilia, licensed under <http://www.formez.it/iocl/> and updated by licensee September 1, 2013.

Includes contents of Provincia di Enna, Comune di Torino, Comune di Pisa, Comune di Trapani, Comune di Vicenza, Regione Lombardia, Regione Umbria, licensed under <http://www.dati.gov.it/iocl/2.0/> and updated by licensee September 1, 2013.

Includes content of GeoforUs, licensed in accordance with <http://creativecommons.org/licenses/by/3.0/legalcode>.

Includes content of Comune di Milano, licensed under <http://creativecommons.org/licenses/by/2.5/it/legalcode> and updated by licensee November 1, 2013.

Includes content of the "Comunità Montana della Carnia", licensed under <http://www.dati.gov.it/iodl/2.0/> and updated by licensee December 1, 2013.

Includes content of "Agenzia per la mobilità" licensed under <http://creativecommons.org/licenses/by/3.0/legalcode> and updated by licensee January 1, 2014.

Includes content of Regione Sardegna, licensed under <http://www.dati.gov.it/iodl/2.0/> and updated by licensee May 1, 2014.

Includes content of CISIS, licensed under <http://creativecommons.org/licenses/by/2.5/legalcode>.

Norway: Copyright © 2000; Norwegian Mapping Authority

Includes data under the Norwegian licence for Open Government data (NLOD), available at <http://data.norge.no/nlod/en/1.0>

Contains information copyrighted by © Kartverket, made available in accordance with <http://creativecommons.org/licenses/by/3.0/no/>.

Contains data under the Norwegian licence for Open Government data (NLOD) distributed by Norwegian Public Roads Administration (NPRA)

Portugal: Source: IgeoE – Portugal

Spain: Información geográfica propiedad del CNIG

Contains data that is made available by the Generalitat de Catalunya Government in accordance with the terms available at http://www.gencat.cat/web/eng/avis_legal.htm. Retrieved by HERE 05/2013.

Contains content of Centro Municipal de Informática – Malaga, licensed in accordance with <http://creativecommons.org/licenses/by/3.0/legalcode>.

Contains content of Administración General de la Comunidad Autónoma de Euskadi, licensed in accordance with <http://creativecommons.org/licenses/by/3.0/legalcode>

Contains data made available by the Ayuntamiento de Santander, licensed in accordance with <http://creativecommons.org/licenses/by/3.0/es/legalcode.es>

Contains data of Ajuntament de Sabadell, licensed per <http://creativecommons.org/licenses/by/3.0/legalcode>, updated 4/2013

Sweden: Based upon electronic data © National Land Survey Sweden.

Contains public data, licensed under Go Open v1.0, available at <http://data.goteborg.se/goopen/Avtal%20GoOpen%201.0.0.pdf>

Switzerland: Topografische Grundlage: © Bundesamt für Landestopographie

United Kingdom: Contains public sector information licensed under the Open Government Licence v1.0 (see for the license <http://www.nationalarchives.gov.uk/doc/open-government-licence/>)

Adapted from data from the office for National Statistics licensed under the Open Government Licence v.1.0

Canada: This data includes information taken with permission from Canadian authorities, including © Her Majesty, © Queen's Printer for Ontario, © Canada Post, GeoBase®, © Department of Natural Resources Canada. All rights reserved.

Mexico: Fuente: INEGI (Instituto Nacional de Estadística y Geografía)

United States: ©United States Postal Service® 2013. Prices are not established, controlled or approved by the United States Postal Service®. The following trademarks and registrations are owned by the USPS: United States Postal Service, USPS, and ZIP+4.

Includes data available from the U.S. Geological Survey.

Australia: Copyright. Based on data provided under license from PSMA Australia Limited (www.psm.com.au).

Product incorporates data which is © 2013 Telstra Corporation Limited, Intelomatics Australia Pty Ltd and HERE International LLC.

Nepal: Copyright © Survey Department, Government of Nepal.

Sri Lanka: This product incorporates original source digital data obtained from the Survey Department of Sri Lanka

© 2009 Survey Department of Sri Lanka

The data has been used with the permission of the Survey Department of Sri Lanka

Israel: © Survey of Israel data source

Jordan: © Royal Jordanian Geographic Centre.

Mozambique: Certain Data for Mozambique provided by Cenacarta © 2013 by Cenacarta

Nicaragua: The Pacific Ocean and Caribbean Sea maritime borders have not been entirely defined. Northern land border defined by the natural course of the Coco River (also known as Segovia River or Wangki River) corresponds to the source of information available at the moment of its representation.

Réunion: source: © IGN 2009 - BD TOPO ®

Ecuador: INSTITUTO GEOGRAFICO MILITAR DEL ECUADRO
AUTORIZACION N° IGM-2011-01- PCO-01 DEL 25 DE ENERO DE 2011

Guadeloupe: source: © IGN 2009 - BD TOPO ®

Guatemala: Aprobado por el INSTITUTO GEOGRAFICO NACIONAL – Resolución del IGN No 186-2011

French Guiana: source: © IGN 2009 - BD TOPO ®

Martinique: source: © IGN 2009 - BD TOPO ®

Index

Symbols

Auto mode..... 13, 20, 22

SCENE Scene mode..... 23

A Aperture-priority auto mode
..... 31, 33

S Shutter-priority auto mode
..... 31, 33

Short movie show mode
..... 28

P Programmed auto mode
..... 31, 33

Smart portrait mode..... 25

M Manual mode..... 31, 33

Playback mode..... 18

List by date mode..... 23

T (Telephoto)..... 17

W (Wide-angle)..... 17

Playback zoom..... 18, 21

Thumbnail playback
..... 18, 22

Help..... 24

Flash mode..... 35

Self-timer..... 37

Macro mode..... 39

Exposure compensation
..... 41, 43

Wi-Fi button
..... 2, 56, 50, 52

Playback button..... 2, 18

Map button
..... 2, 55, 35, 38

(movie-record) button
..... 2, 20, 43

Apply selection button..... 2

MENU Menu button
..... 2, 47, 49, 51, 52, 54

Delete button..... 2, 19, 25

N-Mark..... 1, 51, 52

A
AC adapter..... 57, 112

AF area mode
..... 50, 51, 69, 79

AF assist..... 54, 101

AF-assist illuminator..... 1

A-GPS file..... 87

Aperture value..... 17, 31

Aperture-priority auto mode
..... 31, 33

Auto flash..... 36

Auto mode..... 13, 20, 22

Auto off..... 15, 54, 102

Auto with red-eye reduction..... 36

Autofocus..... 50, 51,
 17, 45, 72, 80

Autofocus mode
..... 50, 51, 72, 80

B
Backlighting 23, 6

Battery..... 7, 8, 12, 18

Battery chamber..... 7, 112

Battery-chamber/memory card slot
cover..... 2, 7

Battery charger..... 9, 112

Battery latch..... 7

Battery level indicator..... 13

Beach 23

Blink proof..... 50, 74

- Brightness..... 54, 97
- Button sound..... 102
- C**
- Calculate distance 89
- Calendar display 22
- Capturing still images during recording movies..... 46
- Charge by computer 54, 104
- Charge lamp..... 2, 8
- Charger..... 9, 112
- Charging AC adapter 8, 4, 18
- Close-up 23, 5
- Cloudy..... 62
- Command dial..... 1, 31
- Computer..... 58, 58
- Conformity marking.... 54, 105
- Connecting to smart devices 50, 93
- Connector cover..... 1, 8, 57
- Continuous..... 49, 65
- Create log 39
- Creative slider..... 40
- Crop..... 21, 31
- Cross process 8
- Current settings 94
- D**
- Date and time 11, 54, 95
- Date format..... 11, 95
- Date stamp..... 54, 99
- Daylight..... 62
- Daylight saving time 11, 12, 95
- Delete..... 19, 25
- Digital zoom..... 17, 54, 101
- Direct print..... 58, 54
- Displaying maps..... 35, 38
- Distance units..... 88
- D-Lighting..... 52, 27
- Dusk/dawn 23
- E**
- Easy panorama 23, 11
- Easy panorama playback..... 13
- Editing images 26
- EH-71P..... 18
- Electronic compass 91
- EN-EL12..... 18
- Exposure compensation 25, 41, 43
- Exposure mode 31
- Eyelet for camera strap iii, 1
- E**
- Face detection 16
- Face priority 51, 16, 69, 79
- File name..... 111
- Fill flash 36
- Fireworks show 23, 6
- Firmware version..... 54, 105
- Fixed range auto..... 68
- Flash..... 1, 35, 62
- Flash lamp..... 2, 16
- Flash mode..... 35, 36
- Fluorescent..... 62
- Focus 50, 51, 16, 69, 79
- Focus area 14
- Focus indicator 3, 14
- Focus lock 19
- Food 23, 5
- Format card..... 7, 54, 103

Format internal memory	54,	103	
Format memory	54,	103	
Format memory cards	7, 54,	103	
Formatting	7, 54,	103	
Frame rate	51,	82	
Full-frame playback	18,	21	
Full-time AF	51,	72,	80
Functions that cannot be used simultaneously		44	

G

Glamour retouch	25, 52,	28
-----------------	---------	----

H

HDMI cable	58,	53	
HDMI micro connector	1, 57		
HDR		66	
Help		24	
High-contrast mono.		88	
High-speed continuous		65	
Histogram		41	
HS movie	51,	76,	78
Hue		42	

I

Image copy	52,	85
Image quality	49,	60
Image review	54,	97
Image selection		53
Image size	49,	61
Internal memory		7
Internal memory indicator	3, 5, 13	
Interval		73
ISO sensitivity	49,	68

L

Landscape		23	
Language	54,	103	
Lens	1,	6,	15
Lens cover		1	
List by date mode		23	
Location data options		87	

M

M exposure preview	50,	72		
Macro mode		39		
Manual mode		31, 33		
Map display		35,	38	
Mark for Wi-Fi upload		52,	52,	82
Memory card		5,	19	
Memory card slot		7		
Metering		64		
Microphone (stereo)		1		
Micro-USB connector		1, 8, 57		
Mode dial		1, 13, 20		
Monitor	2, 3, 10,	6		
Monitor settings	54,	97		
Movie editing		47,	48	
Movie menu	47, 51,	75		
Movie options	51,	75		
Movie recording	20,	43		
Movie VR	51,	81		
Multi selector	2, 18, 21, 47			

N

NFC	1,	51,	52
Night landscape		23,	5
Night portrait		23,	4
Nikon Transfer 2		59	
N-Mark	1,	51,	52
Nostalgic sepia SEPIA		8	

- Number of exposures remaining 13, 60
- Number of shots..... 73
- Q**
- Optical zoom 17
- Optional accessories..... 112
- Options..... 93
- P**
- Paper size 55, 56
- Party/indoor 23, 4
- Pet portrait auto release 7
- Pet portrait 23, 7
- Photo info 54, 97
- Photo VR..... 54, 100
- PictBridge..... 58, 54
- Playback..... 18
- Playback menu 47, 52, 82
- Playback mode 18
- Playback zoom..... 18, 21
- Points of interest (POI)
..... 34, 90
- Pop **POP** 8
- Portrait 23
- Power connector cover
..... 2, 112
- Power switch/power-on lamp
..... 1, 11
- Pre-focus..... 50, 72
- Preset manual 63
- Pre-shooting cache
..... 65, 67
- Pressing all the way 17
- Pressing halfway 17
- Print 58, 55, 56
- Printer..... 58, 54
- Programmed auto mode..... 31, 33
- Protect..... 52, 84
- Q**
- Quick effects..... 18, 26
- Quick retouch..... 52, 27
- R**
- Rechargeable Li-ion battery ... 18
- Recording movies 20, 43
- Recording slow motion movies
..... 51, 76, 78
- Red-eye correction..... 52, 28
- Red-eye reduction 36
- Remaining movie recording time
..... 43, 44
- Reset all..... 54, 105
- Restore default settings..... 94
- Rotary multi selector
..... 2, 18, 21, 47
- Rotate image..... 52, 84
- S**
- Scene auto selector 23, 3
- Scene mode..... 20, 23, 3
- SD memory card 5, 19
- Security settings..... 51, 93
- Selective color 8
- Self-Collage 27, 50, 73
- Self-timer 37
- Self-timer lamp 1, 38
- Sequence display options
..... 53, 86
- Set clock from satellite
..... 91
- Setup menu 54, 95
- Shooting 13, 20
- Shooting menu..... 47, 49, 62
- Shooting mode 20

Short movie show mode.....	28	Time zone and date	11, 54,
Shutter sound.....	73, 102	Toy camera effect 1 1.....	8
Shutter speed.....	17, 31, 20	Toy camera effect 2 2.....	8
Shutter-priority auto mode	31, 33	Tripod socket.....	2, 17
Shutter-release button ...	1, 14, 17	TV.....	58, 53
Single.....	49, 65	U	
Single AF.....	51, 72, 80	Upload from camera	52, 93
Skin softening	25, 17, 29	USB cable... 8, 58, 54, 58	
Slide show	52, 83	V	
Slow sync	36	Vibration reduction	51, 54, 81, 100
Small picture	52, 30	View log.....	42
Smart portrait menu.....	47, 73	ViewNX 2.....	58, 58
Smart portrait mode	25	Vividness	25, 42
Smile timer.....	26	Volume.....	47
Snow	23	W	
Soft SOFT	8	White balance.....	49, 62
Sound settings.....	54, 102	Wide-angle	17
Speaker	2	Wi-Fi button	2, 56, 50, 52
Special effects	23, 8	Wi-Fi options menu	47, 50, 93
Sports	23, 4	Wind noise reduction	51, 81
Standard flash.....	36	Wireless LAN....	56, 50, 93
Strap	iii	Wireless Mobile Utility... 56, 50	
Subject tracking.....	70, 71	Z	
Sunset	23	Zoom.....	17
I		Zoom control.....	1, 17
Target finding AF	50, 18, 70	Zoom in.....	17
Telephoto	17	Zoom out	17
Text input.....	94		
Thumbnail playback.....	18, 22		
Time difference	95		
Time-lapse movies	23, 9		
Time zone	12, 95		

No reproduction in any form of this manual, in whole or in part (except for brief quotation in critical articles or reviews), may be made without written authorization from NIKON CORPORATION.

NIKON CORPORATION

© 2015 Nikon Corporation



FX5B02(11)
6MN52011-02